



D771-ET MiniPurge[®] Manual ML435 & ML384



Important Note:

It is essential for safety that the installer and user of the Expo system follow these instructions.

Please refer to the standard for principles and definition.

These instructions apply only to the pressurizing system. It is the responsibility of the manufacturer of the pressurized enclosure to provide instructions for the enclosure.

Expo Technologies reserves the right to replace any component, with one of the equivalent functionality.



CONTENTS

Section 1: System Specification	3
MiniPurge® Control Unit Data	4
Relief Valve Unit and Purge Outlet Valve with integral spark arrestor	5
Section 2: Quick User Guide	6
Installation	6
Operation of the System	6
Section 3: Application Suitability	7
Section 4: Description and Principle of Operation	8
Section 5: Main Components	9
Air Supply Filter / Regulator	9
Logic Air Supply Regulator	9
Minimum Pressure Sensor	9
Purge Flow Sensor	9
Intermediate Sensor	9
Electronic Purge Timer	9
Purge Complete Valve	10
OR Gate	10
Alarm Only Circuit (/AO)	10
Visual Indicators	10
Power Interlock Switch	10
Alarm / Pressurized Switch	10
System Purging Switch (Optional)	11
Intermediate Switch	11
Purge Valve	11
Purge Flow Restrictor	11
CLAPS Sensor	11
CLAPS Regulator	11
Relief Valve Unit	11
Intrinsically Safe Terminal Box	11
Section 6: Installation of the System	12
Relief Valve Unit	12
Air Supply Quality	12
Pipe Work	12
Multiple Enclosures	12
Provision and Installation of Alarm Devices	12
Power Supplies and their Isolation	12
Power Interlock Switch	12
Section 7: Commissioning	13
Commissioning the System	13
Normal Operation	16
Section 8: Maintenance of the System	16
General maintenance	16
Additional maintenance checks	16
Maintenance of Electronic Timer	16
Re-calibration of the Relief Valve Unit	16
Re-calibration of the Pressure Sensors	17
Section 9: Fault Finding	18
General Information	18
System purges correctly but trips and auto re-purges at the end of the purge time	18
Relief Valve opens (continuously or intermittently)	19
System enters purging but purge indication does not occur	19
System begins purging but cycles fail to complete	19
Section 10: Recommended Spares List	20
Section 11: Glossary	20
Section 12: Drawings and Diagrams	20
Section 13: FM ML384 Manual	21
Section 14: Certifications	28



Section 1: System Specification

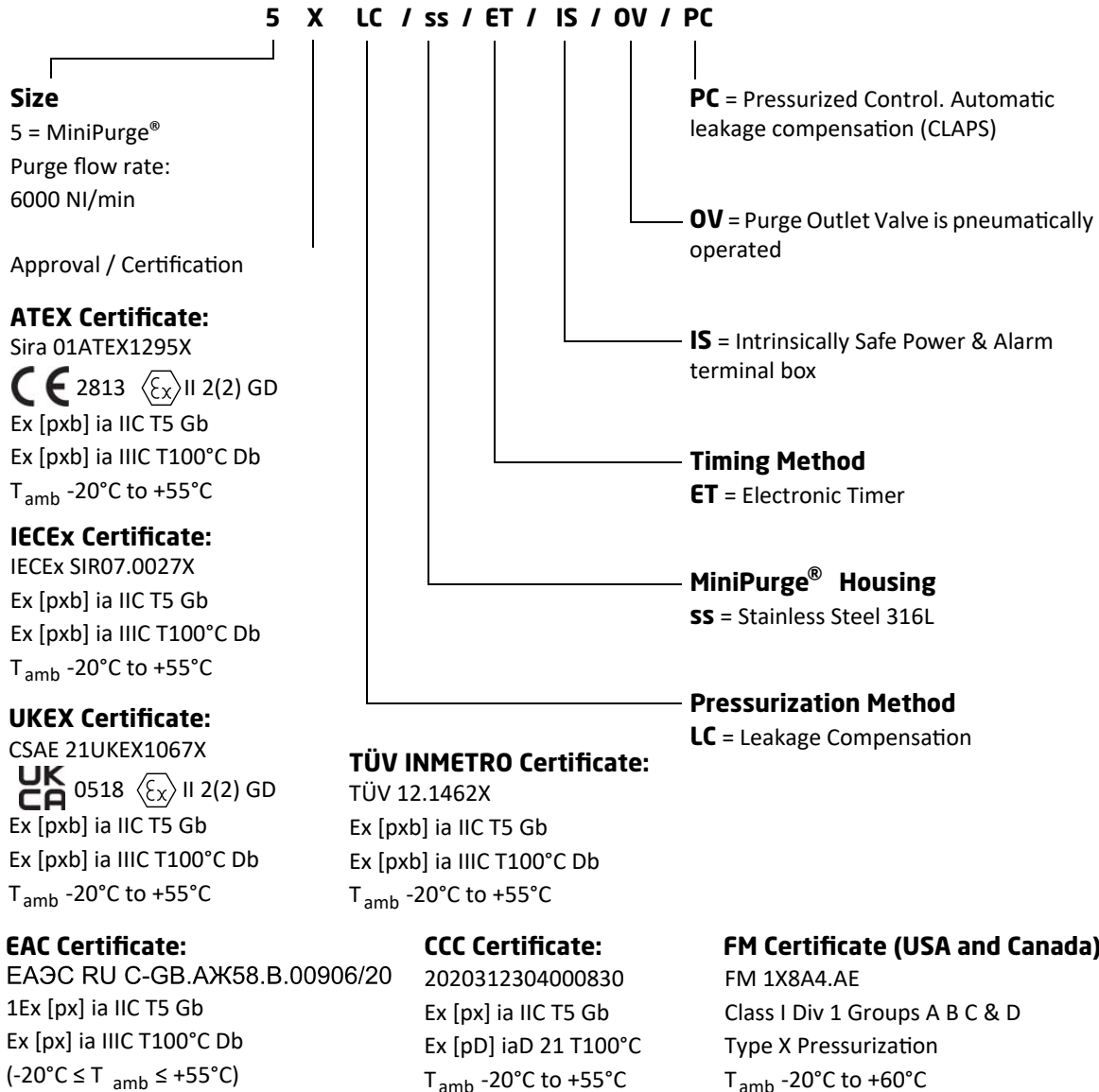

APPLICABLE SPECIFIC CONDITIONS OF USE:

1. The installer/user shall ensure that the MiniPurge Control Unit is installed in accordance with the equipment certificate that covers the combination of the pressurised enclosure(s) and MiniPurge Control Unit.
 2. The values of the safety parameters shall be set in accordance with the equipment certificate that covers the combination of the pressurised enclosure(s) and MiniPurge Control Unit.
 3. This MiniPurge Control Unit shall be incorporated into equipment and the appropriate Conformity Assessment Procedures applied to the combination, as defined by IECEx rules, Directive 2014/34/EU or UKCA Regulations, as applicable.
- For further details refer to the applicable certificates in Section 14 of this manual.

Refer to Section 13 of this manual for FM specific manual ML384



MiniPurge® Control Unit Data

Action on Pressure Failure:	Alarm and Trip (isolate power to pressurized enclosure), user adjustable Alarm Only.
Type of Operation:	Automatic leakage compensation using the Closed Loop Automatic Pressurization System (CLAPS System).
Leakage Compensation Capacity	1500 NI/min max.
Enclosure Material:	Stainless Steel 316L.
Mounting Method:	Wall mounting straps. Fixing holes as per drawing.
Temperature Limits:	-20°C to +55°C
Compressed Air Supply:	Clean, dry, oil free air or inert gas. Refer to Air Supply Quality section in Installation of the System.
Supply Pressure:	5 to 16 barg (73 to 232 psi).
Main Regulator:	Set at 5 barg, 40 mm automatic drain supply inlet filter.
Logic Regulator and Gauge:	Fitted and set to 2.5 barg (36 psi).
Process Connections:	Purge supply and outlet to pressurized enclosure 1" NPT female. Minimum supply line 25 mm (1") ID tube, inlet sized appropriately for flow rate. Reference points & signals 1/8" NPT female, minimum 6 mm pipe to be used.
Visual Indicators:	Alarm (Red ●) / Pressurized (Green ●). System Purging: 4 LEDs that flash sequentially to indicate elapsed time (black when not purging).
/IS Terminal Box:	Stainless steel, for intrinsically safe circuits only, c/w blue terminals, front access cover and lower removable gland plate.
Power Interlock Switch:	Volt Free contacts for the connection of Intrinsically Safe Circuits.
Alarm Switch:	Volt Free contacts for the connection of Intrinsically Safe Circuits.
Intermediate Switch:	Volt Free contacts for the connection of Intrinsically Safe Circuits.
System Purging Switch (Optional):	Volt Free contacts for the connection of Intrinsically Safe Circuits.
Minimum Pressure Sensor:	Minimum: 0.5 mbarg. Maximum: 5.0 mbarg. Default Setting: 1.5 mbarg. Tolerance -0, +0.7 mbarg
Intermediate Sensor:	Minimum: 2.0 mbarg. Maximum: 10 mbarg. Default Setting: 5.0 mbarg. Tolerance: -0, +10%.
Note: There must be a 1.5 mbarg difference between the minimum pressure and intermediate sensors.	
Purge Flow Sensor:	Set at 6.4 mbarg (Tolerance: -0, +10%).
CLAPS Sensor:	Minimum: 5.0 mbarg. Maximum: 15 mbarg. Default Setting: 10 mbarg. Tolerance: -0, +10%

**Note: there must be a 2.5 mbarg difference between the intermediate and CLAPS sensor calibration point.
For example: Minimum pressure = 5 mbarg, intermediate pressure = 6.5 mbarg, CLAPS sensor = 9 mbarg.**



Purge Time: User selectable, in 1 minute intervals, up to 99 minutes (tolerance - 0, +3 seconds).
Default Setting 99 minutes.

Weight: 27 kg (60lb).

Relief Valve Unit and Purge Outlet Valve with integral spark arrestor

Type: RLV104/ss/FS, Design number D758RLV.

Bore: Purge Outlet Valve \varnothing 104 mm, Relief Valve \varnothing 75 mm.

Relief Valve Lift-Off Pressure: Minimum: 20 mbarg.
Maximum: 50 mbarg.
Default: 30 mbarg (+0, -20%).

Flow Rate: Range: 2000, 3000, 4000, 5000, or 6000 NI/min.
Default: 2000 NI/min.

Material: Housing: Stainless steel 316L.
Gasket: Silicone foam.
Spark arrestor: Stainless steel mesh.

Mounting Method: Rectangular cut-out and fixing holes as per drawing.

Weight: 7 kg (15.4 lb).



Section 2: Quick User Guide

Installation



The MiniPurge® System must be installed by a competent engineer, in accordance with relevant standards, such as IEC / EN 60079-14 and any local codes or practice.

- Mount the purge system in accordance with the hook-up drawing.
- Ensure the system is installed according to the full instructions in the “Installation of the System” section of this manual.
- All piping must be clean and free of dirt, condensation and debris prior to connection to the purge system or pressurized enclosure.
- It is strongly recommended that a local isolation valve is installed on the air supply upstream of the purge system.

Note: Most faults are due to restricted air supply, inadequate supply pipe work or drop in air supply pressure during the purge process.



Operation of the System

Once the system is installed correctly, turn on the air supply. Refer to Commissioning section.



Indicator	Colour	Status
Alarm / Pressurized	Red 	Low pressure alarm (enclosure pressure too low)
Purging	Black 	

The purge system commences the purge cycle:

- The purge air will enter the enclosure.
- The pressurized enclosure will obtain a positive pressure.
- The Purge Outlet Valve will open within the Relief Valve Unit.
- The air will then exit the Relief Valve Unit housing via the spark arrestor.

Indicator	Colour	Status
Alarm / Pressurized	Green 	Pressurized (minimum enclosure pressure achieved)
Purging	Black 	Purge flow too low



Open the Purge Flow Restrictor Valve until the air flow reaches the required rate; the system will initiate the timed purge cycle. Start a stopwatch when the purging indicator flashes yellow.

Indicator	Colour	Status
Alarm / Pressurized	Green 	Pressurized
Purging	Sequential flashing Yellow 	Purge flow rate above minimum

On completion of an uninterrupted purge cycle of the required length, the system will indicate purge complete.



Stop the stopwatch when the purging indicator stops flashing.

Indicator	Colour	Status
Alarm / Pressurized	Green 	Pressurized and in leakage compensation mode
Purging	Black 	No longer in purge mode

Check stopwatch timing to verify that the actual purge time is equal to or greater than the required purge time.

Note: The recorded purge time must never be less than the required purge time.

The system is now operating correctly in leakage compensation mode.

If the system has not performed as expected, check the installation thoroughly and ensure it has been carried out according to the instructions.

If an obvious problem has not been highlighted and corrected, follow the procedures in the Fault Finding section.

If all checks have been carried out and the system still does not perform as expected, contact your local distributor or Expo Technologies.

Section 3: Application Suitability

MiniPurge® systems are certified for use in hazardous locations, where the hazardous location is non-mining (above ground) and the hazard is caused by flammable gasses, vapours or dust. Depending on the model the systems may be used in IECEx and ATEX Zone 1(21) and/or Zone 2(22) - Categories 2 and 3 respectively - or NEC 500 Class I Division 1 & 2.

MiniPurge® systems may be used for hazards of any gas group. Apparatus associated with the MiniPurge® system, such as intrinsically safe signalling circuits and flameproof enclosures containing switching devices may be limited in their gas group. The certification documentation supplied with any such devices must be checked to ensure their suitability.

This system is primarily designed for use with compressed air. Where other inert compressed gasses are used (Nitrogen, for example) the user must take suitable precautions so that the build up of the inert gas does not present a hazard to health. Consult the Control of Substances Hazardous to Health (COSHH) data sheet for the gas used. Where a risk of asphyxiation exists, a warning label must be fitted to the pressurized enclosure.

The following materials are used in the construction of MiniPurge® systems. If substances that will adversely affect any of these materials are present in the surrounding environment, please consult Expo Technologies for further guidance.

Materials of Construction		
Stainless Steel	Aluminium	Acrylic
Mild (Carbon) Steel	Nylon	Silicone
Brass	Polyurethane	Neoprene
ABS	Polycarbonate	Polyester (glass filled)

Section 4: Description and Principle of Operation

The MiniPurge® system is pneumatic in operation, with electrical interfaces.

Purge and pressurization is a method of protection used in Zone 1 (21) and/or Zone 2 (22) and Class I Div 1& 2 hazardous locations to ensure that the interior of an enclosure is free of flammable gas. Addition of a MiniPurge® system allows the electrical equipment within the enclosure to be used safely in a hazardous location.

The principle of purge and pressurization is as follows:

- Clean compressed air or inert gas is drawn from a non-hazardous location.
- The interior of the pressurized enclosure is flushed to remove any hazardous gas or dust.
- This is introduced into the pressurized enclosure to keep the internal pressure at least 0.5 mbarg above the external pressure.
- Whilst pressurized, flammable gas cannot enter the enclosure from the environment.

Prior to switching on the power to the electrical equipment, the enclosure must be purged to remove any flammable gas that might have entered the enclosure before pressurization. Purging is the process of removal contaminated air and replacement with air (or inert gas) known to be free from flammable gas. The duration of this purge process is normally ascertained by performing a purge test.

At the end of the purge cycle the system automatically switches to leakage compensation mode. The Purge Outlet Valve is closed and the airflow is reduced but remains high enough to compensate for the leakage of air from the enclosure whilst maintaining the minimum over pressure state.

In the event of pressure failure within the pressurized enclosure the system will raise an alarm in the form of visual indicators and a volt free contact depending on the specification of the system. The default action on loss of pressurization is alarm and automatic disconnect of power (A&T - Alarm and Trip). This can be changed by the customer to Alarm Only (/AO), please refer to section titled Main Components.

The MiniPurge® system incorporates a Closed Loop Automatic Pressurization System (CLAPS). This allows the system to detect a rise or fall of the enclosure's internal pressure and adjust the leakage compensation rate accordingly. Pressure variations are more likely during sudden start up of large rotating electrical machines but can also be caused by changes in running temperature. This system has been specifically designed to maintain a stable internal pressure within the enclosure.

Pressure characteristics during purge and pressurization of a pressurized enclosure using a MiniPurge® system that incorporates a CLAPS system:

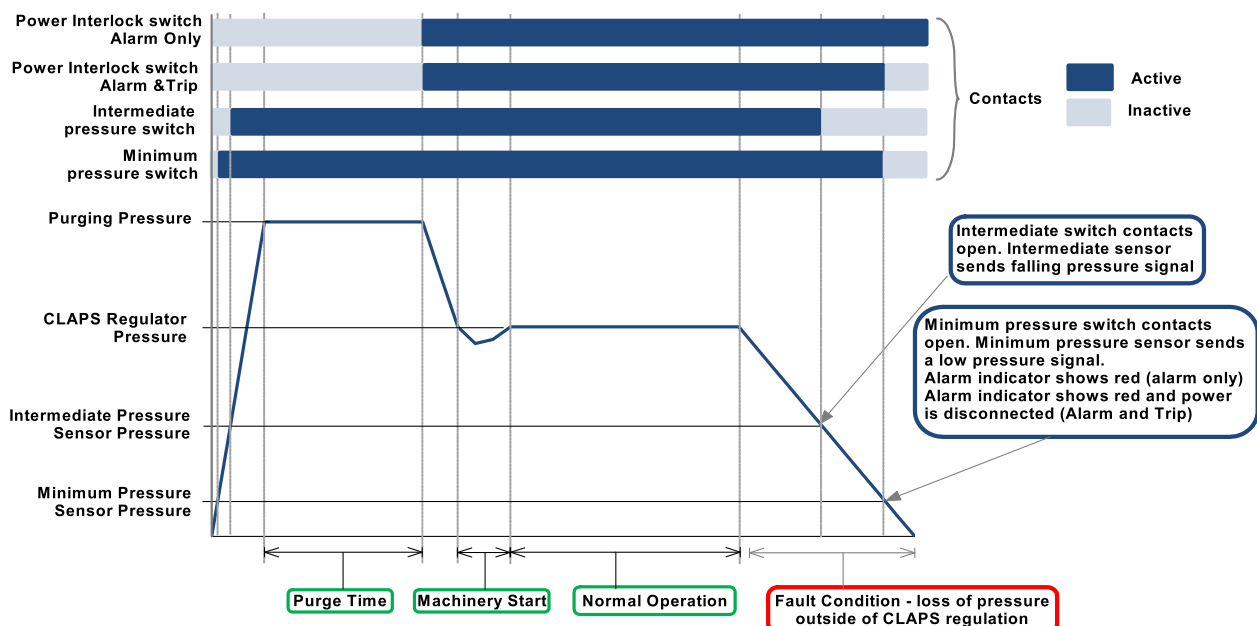



Section 5: Main Components

Air Supply Filter / Regulator

The unit is provided with a 50 µm liquid / dust filter element as a precaution. The user of the MiniPurge® system must ensure that air supply is to the quality stated in Air Supply Quality paragraph found in the Installation of the System section. The regulator is factory set to 5 barg (73 psig) and regulates the pressure of an air supply between 5 and 16 barg (73 to 232 psig). A pressure gauge is fitted down stream of the filter; this should indicate no less than 5 barg (73 psig). During the purge cycle a pressure drop will be indicated on the gauge.

Logic Air Supply Regulator

This device provides the system with a stable air supply pressure to the logic system and allows consistent operation. The pressure level is factory set to 2.5 barg (36 psig) and can be verified by means of the integral pressure gauge.

Minimum Pressure Sensor

This monitors the pressure inside the pressurized enclosure. When the pressure is below the minimum required for safe operation, the pressure sensor causes the system to reset and the Alarm / Pressurized indicator turns Red ●. The sensor is factory calibrated and set to operate in falling pressure at or above the minimum specified pressure.

Purge Flow Sensor

The Purge Flow Sensor monitors flow through the Purge Outlet Valve. At correct purge flow rates, above the minimum specified for purging, the sensor sends a signal that activates the purge timer. This sensor is factory calibrated to operate on falling flow rate at or above the minimum specified purge flow rate.

Intermediate Sensor

This sensor monitors the pressure inside the pressurized enclosure. It senses when the pressure is drops and provides early warning before the low pressure sensor trips the system.

Electronic Purge Timer

When both the enclosure pressure and the purge flow rate are correct, the Purge Flow Sensor activates the timer and the electronic timer starts. The timing period is selected using switches mounted on the timer module.

Note: Setting the timer to 00 minutes will cause infinite purging; the cycle will never complete.

During timing, the percentage of the purge cycle is indicated by four LEDs which flashes sequentially while the timer is running.

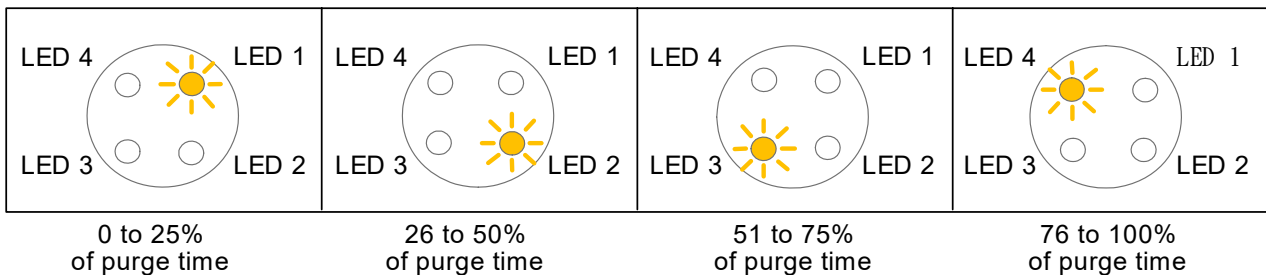

The Electronic Timer contains an intrinsically safe battery pack that needs regular replacement. See Commissioning section.



Purge Complete Valve

This valve receives a signal from the purge timer that indicates the completion of the purge cycle and verifies that the pressurization signal is still present. If both conditions are satisfied a signal is sent to indicate that the purge is complete. This performs two functions: to turn on the electrical supply to the pressurized enclosure and to reduce the high purge flow rate to leakage compensation mode. It also provides a hold-on signal that maintains the leakage compensation mode with the power switch on, even when the purge timer has reset ready for the next purge cycle.

OR Gate

This device provides the Purge Complete Valve with the hold-on function referred to previously. When either the timed-out signal or the purge complete signal is present it allows the pilot signal to be sent to the purge complete valve.

Alarm Only Circuit (/AO)



If the pressure in the pressurized enclosure is too low the system will normally cut off electrical power to it. In certain circumstances, where local codes of practice allow, the system can be altered to provide a hold-on circuit that will maintain the electrical power supply to the pressurized enclosure while also providing a pressure failure alarm. The user must respond to the alarm and either restore the pressure to the pressurized enclosure or otherwise make the installation safe; for example, cut off the electrical supply. The decision to use the Alarm Only facility, and the allowable length of time for non-pressurized operation, is the responsibility of the user.

Warning: It is potentially dangerous to energise the pressurized enclosure in a non-pressurized condition when it is known that there is potentially explosive gas or dust in the hazardous location.



Visual Indicators



Visual indicators are fitted to provide status information to the operator.

Alarm / Pressurized Indicator

Green* 	Pressurized
Red 	Pressure Alarm (enclosure pressure low)

System Purging Indicator

Black* 	Purge flow too low (not in purge mode)
Yellow (flashing) 	Purging (flow above minimum)

* The Green  / Black  combination indicates normal operation of the pressurized enclosure after the initial purging cycle has been completed.

Power Interlock Switch

This flameproof switch is used as simple apparatus for connection to intrinsically safe circuits only. It is activated by the signal from the purge complete valve. This activation can be used to turn on the electrical supply to the pressurized enclosure. The cable from the switch is terminated on the Intrinsically Safe terminal box.

Alarm / Pressurized Switch

This flameproof switch is used as simple apparatus for connection to intrinsically safe circuits only. It is operated by the pressurized signal. It allows remote electrical system status indicator to show either pressurized or a pressure failure alarm. The cable from the switch is terminated in the Intrinsically Safe terminal box.



System Purging Switch (Optional)

This optional flameproof switch is to be used as simple apparatus for connection to intrinsically safe circuits only. It is operated by the purge flow signal. It allows a remote electrical system status indicator to signal that the system is purging; sometimes referred to as purge in progress. The cable from the switch is terminated in the Intrinsically Safe terminal box.

Intermediate Switch

This flameproof switch is used as simple apparatus for connection to intrinsically safe circuits only. It is activated by the signal from the intermediate sensor. The cable from the switch is terminated in the Intrinsically Safe terminal box.

Purge Valve

This changeover valve selects between purge air flow or leakage compensation. It is sized to allow sufficient air into the enclosure during purging based on: the specified air supply pressure range, the minimum specified purging outlet flow rate +10% and the expected leakage rate from the pressurized enclosure. At the end of the purge cycle, the purge valve closes in response to the "Purge Complete" signal; it remains in the closed position until the next purge cycle is initiated.

Purge Flow Restrictor

This valve restricts the purge flow to the minimum required flow rate. The Purge Flow Restrictor must be readjusted during commissioning.

CLAPS Sensor

This sensor monitors the pressure within the pressurized enclosure and sends a control signal to the CLAPS Regulator. The normal running pressure must be determined prior to system start-up so that the CLAPS Sensor may be set to the level required to control the CLAPS Regulator.

CLAPS Regulator

This is the regulator that controls the leakage compensation air flow into the enclosure after the purging is complete. It either increases or decreases the air flow into the enclosure as appropriate to maintain a stable running pressure. The CLAPS Regulator must be set at the time of commissioning.

Relief Valve Unit

The Relief Valve Unit allows the purge air to exit the enclosure safely via a built-in spark arrestor. This spark arrestor is designed to prevent the emission of arcs, sparks and incandescent particles produced within the pressurized enclosure.

Purge air passes through the Relief Valve Unit; the preset pressure differential across the appropriate orifice ensures that the purge flow sensor is activated once the selected purge flow has been attained.

During the purge cycle a pneumatic cylinder operates the Purge Outlet Valve that lets the air from inside the enclosure exhaust through the Relief Valve Unit. When the system changes to leakage compensation mode, the Purge Outlet Valve is closed and the enclosure sealed.

The Relief Valve Unit has an in-built relief valve. This is sized to ensure that, if the air supply pressure rises up from the specified maximum, the internal enclosure pressure will not exceed the specified maximum working pressure of the pressurized enclosure.

Intrinsically Safe Terminal Box

The Terminal Box is for connection of Intrinsically Safe circuits only and incorporates the terminal connection points for the alarm & interlock switches. All contacts provided are Volt free (dry). Cable entry methods (e.g. conduit or glands) shall conform to IEC / European or other relevant local codes and it is recommended to maintain a minimum IP54 ingress protection.



Section 6: Installation of the System

The MiniPurge® is designed for use under normal industrial conditions of ambient temperature, humidity and vibration. Please consult Expo before installing this equipment in conditions that may cause stresses beyond normal industrial conditions. The MiniPurge® system must be installed by a competent person in accordance with relevant standards, such as IEC / EN 60079-14, and any local codes of practice.

The MiniPurge® control unit should be installed either directly on, or close to the pressurized enclosure. It should be installed such that the system indicators and certification labels are in view.

All parts of the system carry a common serial number. If installing more than one system, ensure that this commonality is maintained within each system installed.

Relief Valve Unit

To achieve effective purging, the points where air enters and exits the pressurized enclosure should normally be at opposite ends of the enclosure. The RLV unit must be mounted vertically and there should be a minimum clearance of 300 mm (12") around the spark arrestor (purge outlet).

It is important that the interior and exterior of the spark arrestor is kept clean and debris is not allowed to accumulate; this might affect the calibration of the device. In particular, the exterior of the spark arrestor should not be painted or blocked in any way.

Air Supply Quality

The MiniPurge® system should be connected to a protective gas supply, which is suitable for purging and pressurization.

The supply pipe connection to the MiniPurge® must be appropriate for the maximum input flow rate for the application.

The air supply must be regulated at a pressure less than the maximum stated inlet pressure.

The air supply must be: clean, non-flammable and from a non-hazardous location. The air should be of Instrument Air Quality. Although the purge control system will operate with lower air quality, its operational life will be adversely affected. The equipment that is being protected by the MiniPurge® may also suffer because of poor air quality.

With reference to BS ISO 8573-1: 2010, Instrument Air is typically specified as:

Particle Class 1

In each cubic metre of compressed air, the particulate count should not exceed 20,000 particles in the 0.1 to 0.5 micron size range, 400 particles in the 0.5 to 1 micron size range and 10 particles in the 1 to 5 micron size range.

Humidity or pressure dew point

The dew point, at line pressure, shall be at least 10 °C below the minimum local recorded ambient temperature at the plant site. In no case, should the dew point at line pressure exceed +3 °C.

Oil Class 2

In each cubic metre of compressed air, not more than 0.1mg of oil is allowed. This is a total level for liquid oil, oil aerosol and oil vapour.



When an inert gas is being used to supply the purge system, risk of asphyxiation exists. Refer to Application Suitability section.

Before connection of the air supply to the purge system, the supply pipe work should be flushed through with instrument quality air to remove any debris that may remain in the pipes. This must be carried out for at least 10 seconds for every meter of supply pipe.

Unless a supply shut-off valve has been fitted to the MiniPurge® system, an external shut-off valve with the same, or larger, thread size as the Control Unit inlet fitting should be fitted by the installer to prevent any restriction of purge flow.

The purge air from the MiniPurge® Control Unit should be piped within the pressurized enclosure to ensure purging of potential dead air spots.

The purge system is fitted with an internal regulator factory set to 3 bar feeding the logic.

Pipe Work

If the MiniPurge® is not connected directly to the pressurized enclosure, pipe work and fittings used to connect the Control Unit to the pressurized enclosure should be either metallic or appropriate to the environment into which the system is installed. No valve may be fitted in any signal pipe connecting the Control Unit to the pressurized enclosure. This pipe work must be fitted in accordance with local codes of practice where relevant.

Multiple Enclosures

This system is suitable for the purge and pressurization of the primary pressurized enclosure and its associated terminal boxes.

Provision and Installation of Alarm Devices

When the pressure inside the pressurized enclosure is above the minimum, the Minimum Pressure Sensor returns a positive (pressurized) signal causing the alarm indicator on the control unit to change from red to green.

When the pressure falls below the minimum permissible the positive (pressurized) signal is removed. This absence of signal indicates a low pressure alarm condition and causes the alarm indicator on the control unit to go from green to red.

There are volt free (dry) contacts available within the terminal box for remote usage.

The user must make use of this alarm facility in accordance with the local code of practice for Action on Pressure or Flow Failure. Most codes include the following recommendations:

- Zone 1 Installations: Alarm and Automatic Trip of Power.
- Zone 2 Installations: Alarm Only on pressure or flow failure with power being removed manually.

Power Supplies and their Isolation

All power entering the pressurized enclosure should have a means of isolation. This requirement also applies to any external power sources that are connected to the equipment such as volt-free (dry) contacts within the pressurized enclosure. This is commonly achieved using the Power Interlock Switch.

Power Interlock Switch

This switch is a Double Pole Normally Open, double-break switch: it provides two independent contacts that should be connected in series and used to isolate the power. This can be achieved using suitable certified intrinsically safe barriers. These contacts are terminated and accessible to the user in the terminal box.

It is the responsibility of the user to ensure that the switch is only operated within appropriate technical limits.



The switch must be replaced after any short circuit that occurs within the main circuit; the switch is a piece of encapsulated equipment and as such it is not possible to check the state of the contacts. Technical modifications to the switch are not permitted.

Prior to commissioning, check that the terminal box is clean, the connections have been made properly, the cables laid correctly and all screws in the terminals are secure.

In all cases the application and isolation of power must be controlled by the MiniPurge® system using the power interlock signal.

No switches are permitted between the power switch and the MiniPurge® system other than an authorized manual override circuit.

The safe use of this switch is the responsibility of the user, all electrical installations must conform to local codes of practice.

Exception

Power to apparatus that is already suitable for use in hazardous locations need not be isolated by the MiniPurge® system.

Section 7: Commissioning

Commissioning the System

Note: The steps 11 and 15 to 21 represent detailed commissioning tests

The following equipment is needed for this process:

- Continuity meter
- Gauge manometer (0 to 200 mbarg)
- Differential manometer

If, after commissioning, the system does not perform as expected, refer to the Fault Finding Section.

Follow the steps as outlined:

1. Check all connections and that the Relief Valve Unit is fitted correctly with an unobstructed path to the purge exhaust.
2. Close the Purge Flow Restrictor Valve.
3. Fully open external supply shut-off valve where fitted.
4. Check that the internal logic pressure gauge reads 2.5 barg / 36 psi / 250 kPag.
5. Check that the pressure gauge on main air supply reads 5 barg / 73 psi / 500 kPag.
6. Check that the Pressure Relief Valve is correctly set by disconnecting the minimum pressure sensing pipe at the bulkhead fitting on the input to the MiniPurge®. This will disable all of the pressure sensors.
 - Using a 4 mm nylon tube, connect a manometer to the bulkhead fitting from which the minimum pressure sensing pipe was removed.
 - Open the Purge Flow Restrictor Valve very slowly, until the Pressure Relief Valve opens
 - Check the opening pressure is within calibration limits.
 - This test can be carried out several times to ensure repeatability and compliance.Refer to the Maintenance of the System section if the Relief Valve needs recalibrating.
7. Close the Purge Flow Restrictor Valve.
8. Remove the manometer and reconnect the minimum pressure sensing pipe to the bulkhead fitting.
9. Remove red plug from the top of the Minimum Pressure Sensor and connect a gauge manometer.



10. Connect a differential manometer to the test points on the flow sensor.
11. To check sensor calibration
 - The internal pressure in the pressurized enclosure must be below Relief Valve lift off pressure and above the CLAPS pressure
 - At this time the pressurized indicator should be green.
 - gradually open Purge Flow Restrictor Valve until purging indicator flashes yellow.

Note: For large volumes it may take a long time for the purge flow to start.

 - very slowly close Purge Flow Restrictor Valve until the purging indicator stops flashing yellow.
 - Take a reading from pressure gauge.
12. To set the purge flow rate:
 - Turn on the compressed air to the MiniPurge®.
 - Gradually open the Purge Flow Restrictor Valve until the black / yellow indicator changes to yellow (flashing).
 - The flashing yellow indicator confirms the correct flow rate.
 - The differential pressure should be greater than 6.4 mbarg.
 - The relief valve is supplied with different orifice plates for the specified flow rate. This orifice plate is held in position by two M3 screws and can easily be changed by removing the large cover plate from over the outlet valve assembly and screws.

Warning: When opening the Purge Flow Restrictor Valve, ensure the over pressure within the pressurized enclosure does not exceed the pressure relief valve setting.
13. The purge timer will start as soon as the Purging Indicator flashes yellow. Check that the time delay between the indicator turning to yellow (flashing) and returning to black is not less than the minimum time required for complete purging of the pressurized enclosure. Times in excess of minimum are permitted.
14. After the purge has been completed, the Purge Valve will close and the air flow into the pressurized enclosure will be controlled by the CLAPS Regulator. The initial setting may be too high or too low.
15. Gradually turn the CLAPS Regulator anti-clockwise to reduce enclosure pressure.
16. Reduce regulator until intermediate sensor causes contacts to open.
17. Check the manometer on the minimum pressure sensor.
18. Continue to reduce the CLAPS Regulator to test the minimum pressure sensor.
19. To check operation of Minimum Pressure Sensor, check readings on manometer as system will automatically re-purge when it reaches minimum pressure.
20. While the system re-purges, return the CLAPS Regulator to the initial setting.
21. If minimum pressure is below the set point, refer to the Recalibration section
22. If the setting is too high, continual rising and falling of the enclosure pressure will be seen as the CLAPS Regulator automatically shuts off and reinstates the flow. The CLAPS Regulator should be adjusted to reduce the flow into the pressurized enclosure by turning the adjuster screw anti-clockwise.
23. If the initial setting is too low the CLAPS Regulator may not provide enough air flow causing a gradual decline in enclosure pressure. To increase the flow into the pressurized enclosure, adjust the CLAPS Regulator Relief Valve unit by turning the adjuster screw clockwise.
24. To test the CLAPS settings, create a leak in the system by removing a bolt or loosening a gland plate in order to create a 15mm hole. Remember to replace bolt or retighten gland plate after testing.
25. The setting of the CLAPS Sensor is factory calibrated to the normal working pressure expected in the pressurized enclosure, typically 10 mbarg. The pressure in the pressurized enclosure should be stabilized



as close as possible to this figure. This can be checked by a manometer attached to the minimum pressure sensor.

26. Remove the air supply to the system, remove all test equipment and replace all plugs.

Normal Operation

For normal operation of the system, after commissioning has been carried out it is possible to turn the air supply valve on or off to start or stop the system. After this, the purge and pressurization sequence is automatic.

Section 8: Maintenance of the System

General maintenance

The maintenance of the system outlined in this manual should be supplemented with any additional requirements set out in appropriate local codes of practice.

The following checks should be carried out every 6 - 36 months dependent on environment according to IEC / EN 60079-17

- Tests outlined in the Detailed Commissioning section.
- Ensure that the Relief Valve Unit is free from contamination prior to making any adjustment. To do this:
 - Remove large cover plate using a 8 mm spanner (wrench).
 - Check that the interior and all components are clean and free from contamination.
 - Replace large cover plate.
- Check the condition of the air supply filter element. Clean or replace as necessary.

Additional maintenance checks

The following additional checks are recommended at least every 3 years:

Check that:

- Apparatus is suitable for use in the hazardous location.
- There are no unauthorised modifications.
- The air supply is uncontaminated.
- The interlocks and alarms function correctly.
- Approval labels are legible and undamaged.
- Adequate spares are carried.
- The action on pressure failure is correct.

Maintenance of Electronic Timer

This should be carried out every 3 years.

- The intrinsically safe battery pack associated with the electronic timer should be replaced and the commissioning tests repeated.
- After the timing phase has elapsed, the battery may be hot-swapped in the hazardous location without affecting the operation of the MiniPurge® system

Re-calibration of the Relief Valve Unit

Warning

Incorrect adjustment of the Relief Valve Unit can lead to significant over pressure and result in damage to the enclosure.

If maximum pressure setting is reached, stop adjustment, and reduce the pressure.

To perform the following adjustments, an 8 mm spanner (wrench) and a 2.5 mm hex key will be required. Ensure that the Relief Valve Unit is free from contamination prior to making any adjustment. To do this:

- Remove large cover plate using an 8 mm spanner (wrench).
- Check that the interior and all components are clean and free from contamination.
- Replace large cover plate

To adjust the lift off pressure of the Relief Valve:

- Attach test equipment as described in the Commissioning Section.
- Remove small cover plate.
- Whilst holding the central adjustment screw in position using the hex key, loosen the retaining nut.
- Adjust the hex key clockwise to increase, or anti-clockwise to reduce the lift off pressure.
- Before testing, retighten the locking nut whilst holding the adjustment screw in place.
- Carry out the commissioning tests to check the correct setting of the relief valve after adjustment.
- The adjustment is sensitive, and it is recommended that a 1/4 turn (maximum) adjustments are applied between tests.

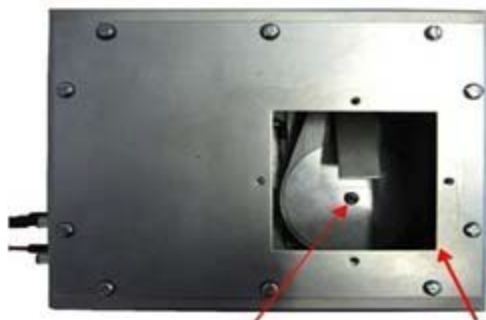

Allen Screw and Lock NUT
Removing the small cover plate to set the RLV opening pressure

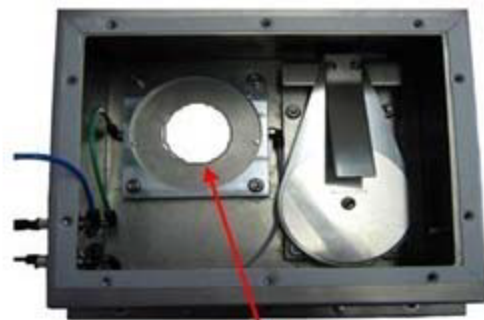

Orifice Plate

Re-calibration of the Pressure Sensors

The brass nozzle on the sensor is sealed into position using Loctite thread sealant. If the thread has seized up, remove to a safe area and heat slightly to soften prior to making any adjustment. This prevents potential damage to the brass of the nozzle.

- Disconnect pipe work from the sensor, including pipe located below the sensor.
- Remove sensor by unscrewing anti-clockwise.
- The nozzle is located under the sensor.
- The adjustment is sensitive, turn the nozzle in 1/8 of a turn step.
- Turn clockwise to reduce the pressure setting and anti-clockwise to increase.
- Replace sensor, screwing clockwise.
- Reconnect all pipe work.



Section 9: Fault Finding

General Information

If you are having problems that cannot be corrected using one of the methods described, please call Expo or your supplier for further assistance. If the system is less than 12 months old, parts under warranty should be returned to Expo for investigation. A full report of the fault and the system serial number should accompany the parts.

It is common for problems with the MiniPurge® system to be caused by contamination of the air supply with oil, water, or dirt. To prevent these problems, the air supply must contain a dust filter and a water filter. This will ensure that the air is instrument quality and protect both the purge system and the equipment being purged. This filtration system is not provided by Expo and must be sourced separately.

Contamination can enter the system from a number of sources. To prevent this, it is essential that the procedures described in the Installation section are carried out prior to first use of the system. These procedures should also be carried out following any disconnection and re-connection of the pipe work. Failure to perform these procedures may cause damage to the system that will not be covered by the warranty. The system has been designed for ease of fault finding and many of the components fitted are plug-in or chassis mounted. Check components by substitution only after establishing that such action is necessary.

Before carrying out the fault finding procedures, ensure that:

- Both the main air pressure to the system and for Motor Purge Systems, the regulated pressure to the logic manifold are as specified on the settings sheet.
- Air pressure does not drop below the minimum supply pressure during purging; most faults reported are due to insufficient air supply during the purge cycle.

System purges correctly but trips and auto re-purges at the end of the purge time.

This is a result of the pressure within the pressurized enclosure being below the minimum pressure sensor setting. The pressure can be checked using a manometer. The most common causes of this problem are outlined below.

Fault Location	Cause	Solution
Pressurized Enclosure	There is debris on the face of the Relief Valve disk held in place by the magnet.	<ul style="list-style-type: none"> • Remove debris and ensure RLV disk is clean.
	Enclosure leaking excessively.	<ul style="list-style-type: none"> • Ensure all doors and covers are closed and that all conduit and cable glands are properly sealed. • Seal any other leaks.
	Pressure sensing tube damaged.	<ul style="list-style-type: none"> • Replace tubing.
CLAPS Regulator	The CLAPS Regulator setting is too low.	<ul style="list-style-type: none"> • Increase the setting of the CLAPS regulator to raise the pressure in the pressurized enclosure after purging. • To do this, turn clockwise.
MiniPurge® Control Unit	the Minimum Pressure Sensor setting has drifted above the CLAPS setting	<p>The Minimum Pressure Sensor needs re-calibrating.</p> <ul style="list-style-type: none"> • Refer to Re-calibration of Pressure Sensors in the Maintenance section



Relief Valve opens (continuously or intermittently)

Fault Location	Cause	Solution
Pressurized Enclosure	Enclosure pressure is too high due to CLAPS Regulator being open too far.	Adjust the CLAPS Regulator.
	Debris on the Relief Valve disk allowing air to leak from the valve.	Remove Relief Valve cover and clean the valve disk.

System enters purging but purge indication does not occur

Fault Location	Cause	Solution
Air Supply	Insufficient flow rate due to inadequate air supply pressure. Often due to pressure drop in the supply pipe.	<p>Static pressure of 5 barg must be maintained during purge</p> <ul style="list-style-type: none"> • Check air supply pressure at the inlet to the control unit. • Ensure that the supply pipe bore is suitable for the flow rate
Pressurized Enclosure	Excessive leakage from the pressurized enclosure.	<ul style="list-style-type: none"> • Check around the enclosure while purging is taking place. • Total leakage at purge outlet valve should not exceed 10% of purge flow sensor setting. • Check for leakage down cables and conduit.
Pipe Work	Tubing from Relief Valve flow sensing point not airtight.	<ul style="list-style-type: none"> • Ensure fitting nuts are tightened. • Check for tube damage. • Repair as necessary.
Relief Valve Unit	Relief Valve opening during purge.	<ul style="list-style-type: none"> • Check enclosure pressure on start up is less than Relief Valve lift off pressure.
MiniPurge Control Unit	Flow sensor setting incorrect.	<ul style="list-style-type: none"> • Check the pressure is correct on the flow sensor.

System begins purging but cycles fail to complete

Fault Location	Cause	Solution
Electronic Timer	Time set to 00	<ul style="list-style-type: none"> • Reset timer to correct purge time.
	The intrinsically safe battery pack is discharged	<ul style="list-style-type: none"> • Replace as necessary.



Section 10: Recommended Spares List

Part Number	Description
S0015/026	Filter kit for S0015/275 filter/regulator
S0030/606	Purge flow sensor factory set to 6.4 mbarg
S0030/016	Minimum Pressure sensor, must be factory set to the value as stated on the Customer Test and Inspection Sheet
S0030/588	CLAPS Sensor must be factory set to the value as stated on the Customer Test and Inspection Sheet
S0015/018	Pressure gauge (Air Supply Pressure), 0 - 10 barg
S0015/135	Miniature gauge (Logic Pressure), 0-4 barg
ETM-IS31-001	IS battery pack for electronic timer module
AGE-GE00-168	Electronic Timer Assembly c/w potted Timer Switch

Section 11: Glossary

Acronym	Definition
A&T	Alarm and Trip
AO	Alarm Only
CLAPS	Closed Loop Automatic Pressurization System
CU	Control Unit
ET	Electronic Timer
FCV	Flow Control Valve
IS	Intrinsically Safe
LC	Leakage Compensation
PA	Power and Alarm
RLV	Relief Valve Unit

Section 12: Drawings and Diagrams

Title	Drawing Number	Number of Sheets
D771 Control Unit - Electronic Timer	D771MOTORSYS-E	2
Typical Hook Up	D771-HU	1
P and I Diagram	D771-PI	1
Circuit Diagram	XBR-7TD0-038	1
Terminal Box Layout	AGE-WC00-164	1
Manual Override Switch Hook-Up	AGE-WC00-186	1
Size 5 MotorPurge RLV	XBR-RTD0-009	1
IS Signal Switch Hook Up Drawing	XSD-6TD0-004	1



Section 13: FM ML384 Manual

**Installation, Operation and Maintenance Manual for MiniPurge®
Leakage Compensation (Model LC) and
MiniPurge® Continuous Flow with High Purge (Model CFHP)
conforming to NFPA 496**

**IMPORTANT NOTE It is essential, to ensure conformity with the standard,
that the user of the system observes the following instructions.**

Please refer to the latest standard for detailed requirements and definitions.

Contents:

Section 0	Description and Principle of Operation	Section 3	Maintenance of the System
Section 1	Installation of the System	Section 4	Fault Finding
Section 2	Operation of the System	Section 5	Annex (if applicable)

Section 0 Description and Principle of Operation

All MiniPurge® pressurization systems provide:

- a) a method of pressurizing a Pressurized Enclosure (PE) while at the same time compensating for any leakage, together with
- b) a method of purging the enclosure, before power is turned on, to remove any flammable gas that may have entered the enclosure while it was not pressurized.

Type **Leakage Compensation (LC)** and **Continuous Flow with High Purge (CFHP)** systems comprise the following two major parts:

- A **Control Unit (CU)** containing as a minimum, for “Y” and “Z” Pressurization, a Leakage Compensation Valve (LCV), Minimum Pressure and Purge Flow sensing devices, and a “Pressurized” / “Alarm” indicator. The CU supplies a ‘Pressurized’ signal showing whether the PE pressure is satisfactory or not.

For Type “X” Pressurization, the CU has, in addition, a fully automatic Purging controller with a Purge timer and electrical power switch interlock.

- A **Relief Valve (RLV)**, fitted to the PE, to provide a means of limiting the maximum pressure experienced by the PE during operation. The RLV model number has suffixes defining the diameter of the valve aperture (in millimeters) and material, e.g. RLV **/cs (Carbon Steel) or /ss (Stainless Steel). All RLVs incorporate a Spark Arrestor to prevent sparks being ejected from the PE through the RLV aperture.

CFHP systems with a Continuous Flow of air after purging have a calibrated Outlet Orifice which can be either within the Relief Valve (suffix **/cf) or a separate item type SA** or SAU**.

0.1 “Leakage Compensation” Systems, Model LC

A Leakage Compensation System, Model LC, is intended to have minimal flow after the initial purge time. The PE is built as leak tight as possible and the LC system merely tops up for any enclosure leakage. The system provides an initial high flow of purging air that leaves the PE through the Relief Valve. After the initial purging has been completed the Control Unit changes over to Leakage Compensation mode and the Relief Valve closes. The only flow thereafter is the flow through the “Leakage Compensation Valve” (LCV) which is adjusted so that the flow is enough to compensate for any leakage from the PE.

The Purging Flow rate is monitored by a separate “Purge Flow Sensor” located in the CU, which detects the differential pressure across the purge flow orifice located directly before the RLV. The Purge Flow Sensor is set to operate when the desired differential pressure is exceeded. The output from the Flow Sensor is indicated on the CU and on “X” Pressurization systems, used to operate the automatic purge timer. Both Enclosure Pressure and Purge Flow have to be correct before the Purge Timer can start.

0.2 “Continuous Flow after High Purge”, Model CFHP System

The CFHP system construction is identical to a LC model, with the addition of one or more fixed Outlet Orifices to provide a deliberate “leak” at a known flow rate. The Outlet Orifice is pre-calibrated so that the pressure drop at the desired flow rate is known. The Minimum Pressure Sensor within the Control Unit will be set to the same value as the pressure drop. When the PE pressure exceeds the calibrated pressure the Continuous Flow must be taking place.

The Leakage Compensation Valve in the CU is opened sufficiently to provide enough air to compensate for any accidental leakage as well as to provide the Continuous Flow through the outlet orifice. In this way a high flow rate is provided during the initial purge period which is thereafter reduced to the desired Continuous Flow rate. Even if the PE had no accidental leakage there would still be a flow from the outlet orifice.

There are three ways of providing the calibrated Outlet Orifice. Please consult the system specification sheet to determine which has been supplied. The choice:

- Type SAU** where an Orifice disk is removable and can be easily changed by the user to give different flow rates according to the size of the PE and the available air supply capacity. (** denotes the metric thread size of the SAU body)
- Type SA** where the orifice size is fixed and the way to change the flow rate is either to change the setting of the Minimum Pressure Sensor or to replace the SA with one of another size. (** denotes the nominal thread size of the SA body)



- For low flow rates, the Outlet Orifice may be incorporated within the Relief Valve making use of the existing Spark

Arrestor. The Relief Valve will then have a suffix /CF**, where ** is the orifice size in millimeters.

Section 1 Installation of the System

The installation of the MiniPurge® system, the protective gas supply, any alarm device should be in accordance with the requirements of NFPA 496.

The electrical installation associated with the MiniPurge® system shall conform to the local codes and the relevant clauses of NFPA 496.

1.1 Installation of the Expo LC and CFHP Systems

1.1.1 The Expo system should be installed either directly on or as close as possible to the Pressurized Enclosure (PE). It should be installed so that the system indicators may be readily observed.

1.1.2 All parts of any system carry a common serial number. If installing more than one system, ensure that this commonality is maintained on each installation.

1.1.3 Any tubing, conduit and fittings used to connect to the PE should be metallic, or, if non-metallic, conform to the local codes for flammability ratings. No valve may be fitted in any tube connecting the Expo system to the PE.

1.1.4 The user or manufacturer of the PE shall determine the volume of the PE, the necessary purging volume, and the time to be allowed for purging, using the chosen Expo system purging flow rate. It is the user's responsibility to verify or enter this data on the PE and/or Expo system nameplate. Ask Expo if in doubt.

Example calculations:

a) If the PE external dimensions give a volume of 20 cubic feet, and it is NOT a motor, multiply the volume by four to get the Purging Volume i.e. 80 cubic feet. Divide the Purging Volume by the purge rate e.g. 32 cubic feet per minute, and round up to the next even minute above, i.e. Purging time would be 4 minutes.

b) If the PE is a motor, multiply the internal free volume by ten to get the Purging Volume. For the example above, Purging time would be 8 minutes.

1.1.5 If the PE contains an internal source of release of flammable gas or vapor, the procedures for assessment of the release as given in NFPA 496 shall be observed. The user must verify that the specification of the Expo system e.g. pressures, continuous flow (dilution) rate and type of protective gas are correct for the specific application. If an inert protective gas is required, the Expo Control Unit can be specified to have Compressed Air for the control logic and Inert Gas for the protective gas to minimize Inert Gas consumption.

1.1.6 More than one PE can be protected by a single system. If PEs are connected and purged in "series" e.g. "Daisy Chained", the Outlet Orifice must be fitted on the last enclosure with the Purge Inlet to the first enclosure. The bore and length of the tube or conduit used to interconnect the enclosures is critical and will determine the maximum pressure experienced by the first enclosure in the series. Advice on sizing can be obtained from Expo Technologies. The test pressure for all the enclosures

should be 3 times the pressure inside the first enclosure when purging is taking place.

If PE's are to be connected in parallel each enclosure must have its own outlet Relief Valve, Purge Flow Sensor and Pressure Sensor. System "Models" can be mixed e.g. Model LC for one enclosure and Model CF for another. An example would be a Gas Chromatograph instrument. Expo systems with this facility have option code "TW".

1.2 Quality and Installation of the Pressurizing Air or Inert Gas Supply

1.2.1 The source of the compressed air must be in a non-classified area. Inert gas may be used as an alternative to compressed air.

1.2.2 Unless a supply shut-off valve has been specially fitted within the Expo system, a valve with the same, or larger, thread size as the Control Unit inlet fitting shall be fitted externally. In addition, for "Y" and "Z" Pressurization systems, a suitable indicator shall be provided.

1.2.3 The tubing and fittings used must conform to 1.1.3 above.

1.3 Provision and Installation of Alarm Devices

Expo Technologies systems have a Minimum Pressure Sensor set to a pressure of at least 0.1" WC (0.25 mbar). When the PE pressure is above this set point the Sensor produces a positive "Pressurized" signal. This is displayed on a Red/Green indicator. This signal can be used to operate an electrical contact for a remote "Alarm". The pneumatic signal may be supplied either

a) to a pressure operated switch (MiniPurge® Option Code /IS) suitable for an Intrinsically Safe circuit, in accordance with Expo drawing EP80-2-11, (or for a Non-Incendive circuit in Division 2), or

b) to a bulkhead fitting where it is available to the user (MiniPurge® Option Code /PO). This signal can be used to operate an external electrical switch either local (e.g. explosionproof) or remote in a non-classified area.

When the enclosure pressure falls below the set point of the Sensor the "Pressurized" signal is removed, i.e. the absence of the signal indicates a "Alarm" ("Pressure Failure") condition. The user must make use of this external alarm facility in accordance with NFPA 496 requirements, if the system "Alarm" indicator is not located in a place where it can be readily observed.

Example: The "Pressurized" signal can be used to produce an "Alarm" action by means of a conventional "pressure switch" set to operate at around 15 psi (1



bar). The "Pressurized" signal from the CU at 30 psi (2 bar) or more will hold the switch in the operated position until the CU detects a low pressure in the PE and removes the "Pressurized" signal. The Alarm switch will reset and its contacts can be used to operate a remote electrical alarm.

If the switch is located in the hazardous area it must either be part of an Intrinsically Safe circuit, or be suitably protected e.g. explosionproof. The pressure switch should be IS or explosionproof even if it is fitted within the Pressurized Enclosure.

Expo Technologies Tip: Exception: For a "Z Purge" system fitted in a Division 2 area, a non-classified switch inside the PE can be used to operate a remote Alarm provided its electrical supply comes from within the PE (i.e. NOT PROVIDING DRY CONTACTS). When the PE is in use the Alarm can operate normally in response to the pneumatic signal from the CU with option /PO. When the PE power is switched off there is no need for an alarm! Ask for the circuit diagram.

The Alarm switch can also be located in a nearby non-classified location. To get the best response time the switch should be as close as possible to the CU and the maximum length of tubing between the CU and the Alarm switch should not exceed 150 feet (45 m) unless "Quick Exhaust Valves" are used (please ask Expo if in doubt).

Note: No valves may be fitted between the Expo system and the alarm switch.

1.4 Power Supplies and their Isolation

1.4.1 All power entering the PE shall be provided with a means of isolation. This requirement also applies to any external power sources that are connected to "dry contacts" or "volt-free contacts" within the PE.

Exception: Power to Intrinsically Safe, or other apparatus, which is already suitable for the location, need not be isolated by the Expo Technologies system.

Expo Technologies Tip: It is recommended to fit dry or volt-free contacts in the non-classified area or inside an explosionproof box rather than inside the PE. Please ask Expo about "MiniPurge" Interface Units" (MIU).

In the case of "X" Pressurization, the isolation of the power must be controlled by the Expo system using the "Purge Complete" pneumatic signal to operate a "Power Switch" in a similar manner to that described in 1.3 above.

In the case of "Y" or "Z" Pressurization the power may be controlled manually by the user by the use of local isolating switch.

1.4.2 In accordance with NFPA 496, Expo Mini-X-Purge[®] systems can have the "Action on Pressure Failure" (normally "Alarm and Trip") adjusted by the user to become "Alarm Only". In case of an alarm, it is the responsibility of the user to de-energize the protected equipment as soon as possible. The system may require the addition of an "Alarm Only Kit" (IAO) to perform this function. Please contact Expo Technologies Sales office for further details.

1.4.3 The Power (cut-off) Switch must be approved for the location or located in a non-classified area.

1.4.4 No valves are permitted between the Power Switch and the Expo system.

1.4.5 For "X" Pressurization, the PE door shall have fasteners that can be opened only by the use of a tool or key. Otherwise the additional requirements from NFPA 496 should apply.

Note: The door switch provided with the Expo system (when requested) can be either pneumatic or electric.

1.5 Marking

1.5.1 The MiniPurge[®] system carries a nameplate and a specification sheet, which give specific data such as serial and models numbers, Pressure Sensor settings, flow rates and purge time.

1.5.2 Other marking, for the PE, required by the standard includes:

"WARNING - PRESSURIZED ENCLOSURE"
This enclosure shall not be opened unless the area is known to be free of flammable materials or unless all devices within have been de-energized"
"Power shall not be restored after the enclosure has been opened until the enclosure has been purged for ___ minutes at a flow rate of ___."

Expo note: It is understood that NFPA 496 requires the de-energization of all devices that are not suitable for the hazard e.g. devices that are not Explosionproof or Intrinsically Safe. For example, an explosionproof anti-condensation heater would not have to be de-energized.

1.5.3 If Inert Gas is used as the Protective Gas and a risk of asphyxiation exists, a suitable warning plate should be fitted to the PE.

Section 2 Operation of the System

2.1 Initial Commissioning

2.1.1 Check that the system has been installed in accordance with Section 1 of this manual.

2.1.2 Disconnect the supply pipe from the inlet to the Control Unit and blow clean air through for at least 5 seconds per foot of length (15 sec / metre) to remove any debris, oil and condensation.

2.1.3 Connect a temporary pressure gauge or liquid manometer to the PE or Control Unit "Pressure Test Point", [on the LP Sensor, by the removal of the Red plug - 5/32" (4mm) OD nylon tube].

2.2 Commissioning Leakage Compensation (LC) and Continuous Flow High Purge (CFHP) "X" Purge systems.



On LC and CFHP "X" Purge systems proceed as follows:

2.2.1 Open the Leakage Compensation Valve (LCV) to about 50% of its travel.

2.2.2 Open the supply shutoff valve SLOWLY and allow the PE pressure to rise until the Relief Valve (RLV) opens. Check that the RLV opens at or below the figure specified in the documentation. Repeat the test several times.

2.2.3 Open the supply shutoff valve fully and the purging flow will start.

2.2.4 Check that the internal logic gauge reads 30 psi (2 bar). If not, adjust the logic pressure regulator to suit (lift the red ring to unlock the knob first.)

2.2.5 At this time the "Pressurized" indicator should be Green and the "Purging" indicator should be Yellow. If the "Purging" indicator remains Black the flow through the Relief Valve is below the minimum for which the Flow Sensor has been calibrated. Check the air supply pressure **at the inlet to the Control Unit while purging is taking place**. It must be above the minimum specified. The larger Super-Mini-X-Purge® system has a built-in gauge on the filter for this purpose.

2.2.6 On LC and CFHP "X" purge systems the purge timer will start as soon as the "Purging" indicator turns Yellow. Check that the time delay between the indicator turning Yellow and the application of power to the PE is not less than the minimum time required to purge the PE. Times in excess of the minimum are permitted and a tolerance of +25% is normally acceptable. If the time is too short it must be adjusted accordingly.

The system uses a pneumatic incremental timer which is adjusted by fully opening or closing one or more of five screwdriver-operated valves, arranged in a block on the control logic manifold – see GA Drawing. The opening of each valve incrementally provides a fixed number of minutes of purging time as in the following table

Valve:	1	2	3	4	5
Minutes:	2	4	8	8	16

Thus for a 12-minute purge time, valves 2 and 3 would be open and the others closed. For twenty-four minutes, 4 and 5 would be open and the others closed. **At least one valve must always be open and the screws must be at the appropriate limit of travel.**

2.2.7 After the power has been turned on by the Control Unit, the Purging Valve will close and the air flow into the enclosure will be controlled by the Leakage Compensation Valve (LCV). The initial setting of 50% open may be too high or too low. It should now be adjusted to set the PE pressure and leakage.

There are three possible situations:

a) Air continues to come out through the RLV Spark Arrestor after power has been turned on in considerable quantity. The LCV is too far open and the air flow is holding the RLV open continuously. (Note: Some CFHP systems have a deliberate but modest "Continuous" air flow through the RLV in normal operation; do not confuse this flow rate with that caused by excessive setting of the LCV.) Close the LCV slowly observing the manometer or gauge (see item 2.1.3 above). The PE pressure will start to fall as the

flow decreases but eventually the RLV will close and the pressure rise again. At this point the Relief Valve may start to open intermittently as the PE pressure rises to the point where the RLV re-closes and the enclosure pressure starts to rise again. This is entirely normal for this type of RLV. Proceed now to b) below:

b) If the Relief Valve is opening intermittently the LCV is slightly too far open. Observe the manometer or gauge. When the RLV opens the enclosure pressure falls quickly to the point where the RLV recloses and the enclosure pressure starts to rise again. This is entirely normal for this type of RLV and shows that it is working correctly.

Then continue to close the LCV until the cycling stops and the enclosure pressure starts to fall. Carefully adjust the LCV until the PE pressure is approximately 50% of the RLV opening pressure and stable. This pressure may be around 2" WC (5 mbar) and will be the "normal working pressure".

We recommend that the setting of the Minimum Pressure Sensor is checked at this time. Note the position of the LCV knob. Slowly lower the PE pressure by closing the LCV further counting the number of turns from the "normal working pressure" position. Note the pressure at which the "Pressurized" indicator turns Red and check that it is not lower than the figure given in the documentation. Check also the "Alarm" electrical contacts (if fitted).

As soon as the "Pressurized" indicator turns Red, the enclosure power will be switched off (see also 2.2.8 below) and the system will start to re-purge.

While it is re-purging return the LCV to its "Normal Working Pressure" position so that, at the end of purging the enclosure pressure should immediately settle down at the correct "normal" pressure. Finally re-adjust the LCV if necessary.

c) If, at the end of purging, the PE pressure falls below the Minimum Pressure Sensor setting the LCV is not open far enough. The system will start to purge again. While it is purging open the LCV fully and check the enclosure for leakage. This time, at the end of purging, the enclosure should stay pressurized and the Relief Valve action be as in a) or b) above. It is likely that there is significant leakage from the enclosure and attempts to reduce the leakage will be time well spent.

CFHP systems are intended to have a Continuous Flow through the enclosure. The Continuous Flow may emerge through the RLV, in which case the RLV will have a "CF" in its model number. Some CFHP systems will have a separate Outlet Orifice/Spark Arrestor and air can be felt emerging through this aperture whenever the enclosure is pressurized.

2.3 Commissioning Leakage Compensation (LC) and Continuous Flow/High Purge (CFHP) "Y" and "Z" Systems.

On LC and CFHP "Y" and "Z" Purge systems, proceed as follows:

2.3.1 Open the supply shutoff valve.



2.3.2 Adjust the Leakage Compensation Valve (LCV) so that the enclosure pressure rises to the point where the “Pressurized” indicator turns green.

2.3.3 Continue to raise the PE pressure until the Relief Valve (RLV) opens. Check that the RLV opens at or below the figure specified in the documentation. Repeat the test several times.

2.3.4 Lower the PE pressure until the “Pressurized” indicator turns Red. Check that the indicator turns Red at or above the pressure specified in the documentation. Check the external alarm contacts (if fitted).

2.3.5 Open the LCV again and set the PE pressure to a level around 50% of the RLV operating pressures. This “working” pressure is not critical. The “Pressurized” indicator should be Green.

2.3.6 Turn the Purge Control Valve “On”. This will start the High Purge Flow and the “Purging” indicator should turn Yellow. If the “Purging” indicator remains Black the flow through the outlet valve is below the minimum for which the Flow Sensor has been calibrated. Check the air supply pressure at the inlet to the Control Unit while purging is taking place. It must be above the minimum specified. (Super-Mini-Purge® systems have a built-in gauge on the filter for this purpose.) If the supply pressure is correct and the “Purging” indicator does not turn Yellow, there is too much leakage from the Pressurized Enclosure. Find and fix the leaks!

“Purging” does not start until the indicator turns Yellow

2.3.7 On LC and CFHP “Z” Purge systems the purge timing function is performed by the user. When the “Purging” indicator turns Yellow the Purge Flow is above the minimum required and the purge time can start. The user must ensure that the time delay between the indicator turning Yellow and the application of power to the PE is not less than the minimum time required to purge the PE as shown on the PE or Expo system nameplate.

Never turn on the power without purging first unless you have proved that the interior of the PE is gas free and checked that the “Pressurized” indicator is green!

2.3.8 After the purge time is completed the Purging Valve should be turned “Off”. The High Purge Flow will cease and the air flow into the enclosure will then be controlled once again by the Leakage Compensation Valve (LCV), it should now be re-adjusted if necessary. The RLV should be closed and the enclosure pressure around 50% of the RLV opening pressure. If this is not so there are three possible situations:

a) Air continues to come out through the Spark Arrestor, after High Purge has been turned “Off”, in considerable quantity. The LCV is too far open and the air flow is holding the RLV open continuously. (Note: Some CFHP systems have a deliberate but modest “Continuous” air flow through the RLV in normal operation; do not confuse this flow rate with that caused by the excessive opening of the LCV.)

Close the LCV slowly observing the manometer or gauge (see item 2.1.3 above). The PE pressure will start to fall as the flow decreases but eventually the RLV will close and the pressure rise again. At this point the Relief Valve will start to open intermittently as the PE pressure rises to the point where it exceeds the RLV opening pressure. When the RLV opens the pressure will fall quickly to the point where the RLV re-closes and the enclosure pressure starts to rise again. This is entirely normal for this type of RLV. Proceed now to b) below:

b) If the Relief Valve is opening intermittently the LCV is slightly too far open. Observe the manometer or gauge. When the RLV opens the enclosure pressure falls quickly to the point where the RLV re-closes and the enclosure pressure starts to rise again. This is entirely normal for this type of RLV and shows that it is working correctly.

Continue to close the LCV until the cycling stops and the enclosure pressure starts to fall. Carefully adjust the LCV until the PE pressure is approximately 50% of the RLV opening pressure and stable. This pressure may be around 2”WC (5 mbar) and will be the “normal working pressure”.

c) If, at the end of purging, the PE pressure falls below the Minimum Pressure Sensor setting the LCV is not open far enough. The LCV should be opened until the PE pressure is around the normal working pressure.

2.3.9 CFHP systems are intended to have a Continuous Flow through the enclosure. The Continuous Flow may emerge through the RLV, in which case the RLV will have a “CF” in its model number. Some CFHP systems will have a separate Outlet Orifice/Spark Arrestor and air can be felt emerging through this aperture whenever the enclosure is pressurized.

2.3.10 “Y” and “Z” purge systems do not control the enclosure power. It is the responsibility of the user to switch off the power whenever the enclosure pressure falls below the minimum permitted i.e. when the “Pressurized” indicator turns Red.

2.4 Normal Operation

2.4.1 “X” Purge systems: Turn the air supply valve On or Off to start or stop the system, After this the Pressurizing and Purging sequence is entirely automatic.

2.4.2 “Y” and “Z” Purge systems are started and stopped in the same way as “X” purge system but the user must close the Power Switch only after the enclosure has been pressurized and purged sufficiently to ensure that the interior of the enclosure is gas free. It is the user’s responsibility to shut off the power, as soon as possible after a pressure failure.



Section 3 Maintenance of the System

The maintenance recommended for the system consists of the following, supplemented by any additional local requirements imposed by the authority having jurisdiction.

3.1 Initial Maintenance

Expo recommends that the commissioning test be repeated at least every six months. They include checking the opening pressure of the Relief Valve, setting of the Minimum Pressure Sensor, the "Normal Working Pressure" of the enclosure and, for "X" Purge systems, the setting of the purge timer (as described in Section 2 of this manual).

In addition, the following checks are also recommended at that time:

- Check the RLV and any other Spark Arrestors. Remove any debris or corrosion, or replace the Spark Arrestor with a spare.

- Check the condition of the air supply filter element. Clean or replace it as necessary.

3.2 Routine Maintenance

At least every two years, the following additional checks are recommended:

- Apparatus is suitable for the Hazardous Location
- There are no unauthorized modifications
- The source of air is uncontaminated
- The interlocks and alarms function correctly
- Approval labels are legible and undamaged
- Adequate spares are carried
- The action on pressure failure is correct

Section 4 Fault Finding – LC and CFHP Systems

4.1 General

If the system does not behave in the manner described above there is a fault. Some of the more likely faults are dealt with below. If a cure cannot be effected by following the procedure shown below please call Expo (24 hour answering) or your supplier for further assistance.

The system has been designed for ease of fault finding and many of the components fitted are plug-in or sub-base mounted. Check components by substitution only after establishing that such action is necessary. If the system is less than 12 months old, parts under warranty should be returned to Expo Technologies for investigation, with a full report of the fault and the system Serial number.

NOTE: As with any pneumatic system the greatest enemies are water, oil and debris in the air supply. For this reason a dust and water filter should always be fitted. But debris can enter from other sources and it is vital therefore that the procedures described in Section 2 is carried out before using the system for the first time, or following any disconnection of the pipework. Failure to perform this work may cause damage, which will not be covered under warranty.

Fault Finding

NOTE: Before making the following checks verify that the main supply pressure is between 60 and 115 psi (4-8 bar) at the Control Unit and, for X-Purge systems, the regulated pressure on the logic gauge is 30 psi (2 bar)

4.2 Minimum Pressure Alarm is ON Continuously ("Pressurized" Indicator is Red)

Possible cause 1: The Pressurized Enclosure (PE) pressure is too low. Try increasing the setting of the Leakage Compensation Valve (LCV) to raise the pressure in the PE.

Possible cause 2: Enclosure fault?

- Is the ACTUAL PE pressure below the setting of the Minimum Pressure Sensor? Check it with a manometer or gauge.
- Is there debris stuck on the face of the Relief Valve disk, perhaps held there because of the magnetic material?
- Has the PE door been closed and all conduit/cable glands sealed?
- Is the PE leaking too much?
- Has the pressure sensing tube been damaged?

Possible cause 3: System fault?

If checks above reveal that the PE is correct, the fault probably lies in the Control Unit. The basic operation of the Minimum Pressure Sensor can be checked by unscrewing the 2.4" (60mm) diameter diaphragm and, by using a finger, block the threaded hole in the top of the valve module. The valve should operate and the indicator should turn Green. If this works correctly and the enclosure pressure is above the setting of the Minimum Pressure Sensor it is likely that the Pressure Sensor diaphragm needs re-calibrating or replacing. (See 4.6)

4.3 Relief Valve Opens (Continuously or Intermittently)

Possible cause 1: The PE pressure is too high.

The Leakage Compensation Valve (LCV) is too far open. Adjust the LCV as described in Section 2 above.

Possible cause 2: Debris on the RLV disk allowing air to leak from the valve. Remove the RLV cover and clean the valve disk. The disk and spring may be removed from the RLV without affecting the calibration.

4.4 "Purging" Indicator Will Not Turn Yellow During Purging



Possible cause 1: Insufficient purging Flow due to inadequate air supply pressure. Check the air supply pressure at the inlet to the CU when flow is taking place. Excessive pressure drop in the supply pipe is a very common cause of this problem. The supply pipe must be at least as big as the CU inlet fitting, i.e. at least ½" NB (12 mm). Super-MiniPurge® systems with ¾" or 1" connections must have AT LEAST this internal diameter for supply and outlet tubing. Due to the high flows demanded from these large systems the need for adequate supply tubing is VITAL. If in doubt, or for long distances, install tubing that is at least 50% larger than the inlet size!

Possible cause 2: Excessive Pressurized Enclosure (PE) leakage. Check around the PE when flow is taking place. Any significant leakage must be cured. Has a Leakage Test been done? The total leakage should not exceed 10% of the Purge Flow Sensor setting. Check for leakage down the conduit through unsealed stopping boxes.

Possible cause 3: PE not strong enough. Repeat the PE pressure test. Is it recommended that the PE is tested to three times the Relief Valve opening pressure e.g. 12"WC (30 mbar) for systems with default settings. Has this been done?

Possible cause 4: The tubing from the RLV Flow Sensing point to the Purge Flow Sensor is not air-tight e.g. fitting nuts not tightened or tube damaged. Check and repair as necessary.

Possible cause 5: The Purge Flow Sensor is not operating correctly or out of calibration. The basic operation of the Purge Flow Sensor can be checked by unscrewing the 2.4" (60 mm) diameter diaphragm and by using a finger, block the threaded hole in the top of the valve module. The valve should operate and the indicator turn Yellow. If this works correctly and the flow through the Relief Valve is above the minimum required WITH THE RELIEF VALVE COVER FIRMLY SECURED IN PLACE the Sensor diaphragm needs re-calibrating or replacing.

4.5 System Fails to Switch Power On after the Purge Time has Elapsed? ("X"-Purge Systems Only)

Possible cause 1: Is power available? Is the power disconnect closed? Are the fuses or circuit breaker OK?

Possible cause 2: System fault? Timer not timed out?

- a) Has the "Purging" indicator been Yellow for the whole of the purge time?
- b) Is the logic pressure gauge at 30 psi (2 bar) ±10%.
- c) Is there pressure at the Power Switch output bulkhead and at the Power Switch itself? Is the Switch set at 15 psi (1 bar)?

d) Is the pipe to the Power Switch airtight? The signal to the Power Switch bulkhead has a restrictor that limits the permissible leakage from the pipe.

e) Note the timer setting. Reset the timer to the minimum available purging period (see 2.2.6) and check operation on that purge time. If it works OK, increase the time progressively until either it is correct, or the system ceases to time out at all. In the latter case, there is an air leak in the timer circuit. (A leak in the timing circuit can cause the timer not to time out.) If possible, establish the source of the leak with soapy water and retest the system. This will involve removing the chassis from the Control Unit – be sure this is the cause before starting the work. It is VERY unusual!!

Ensure that the timer is returned to its original setting and the purge time checked before putting the system back into service.

Possible cause 3: Power Switch Fault. Check the operation of the Power Switch. It should close above 20 psi (1.4 bar).

4.6 Pressure Sensor Calibration

If it is decided that the Minimum Pressure Sensor or Purge Flow Sensor needs re-calibrating it can either be returned to Expo for this service or it can be done by the user as follows:

Disconnect the pressure sensing pipe from the top of the diaphragm. (It is a "push-in" quick release fitting; firmly push inwards the collar surrounding the pipe where it enters the fitting, and then pull the pipe outwards while maintaining the pressure on the collar). Unscrew the 2.4" (60 mm) diameter diaphragm housing from the top of the Sensor. Invert it and note the brass adjusting screw in the center. Turning the screw inwards (clockwise) will lower the setting. It is likely that the screw will be very stiff due to the locking sealant. If the screw cannot be moved the application of gentle heat in the area of the brass screw can often help. DO NOT OVERHEAT!

4.7 Filter Cleaning

If the filter element needs cleaning the transparent bowl can be unscrewed and removed. The filter element also unscrews and can then be cleaned in soapy water. Do not use solvents on any part of the filter assembly.

Expo Technologies tip: It is sometime easier, if the bowl is very tight, to remove the filter by undoing the fitting that holds the filter into the Control Unit. On Sub-Mini-X-Purge® systems it may be necessary to remove the Minimum Pressure Sensor diaphragm first.

Section 5 Annex of Options fitted

Refer to the annex of this manual for any options fitted as designated by the model code of the system



Section 14: Certifications

Certificates can be found in the accompanying booklet ML497.

Component	Certificate	Number
Purge System	EU Declaration of Conformity	SC004 *
	UKCA Declaration of Conformity	SC004-UK *
	ATEX Certificate	SIRA 01ATEX1295X
	IECEX Certificate	IECEX SIR07.0027X
	UKCA Certificate	CSAE 21UKEX1067X
	INMETRO/TÜV Certificate	TÜV 12.1462X
	FM Certificate (USA & Canada)	1X8A4.AE (USA&Canda)
	CCC Certificate	2020312304000830
	EAC Certificate	EAЭC RU C-GB.AЖ58.B.00906/20
Electronic Timer	EU Declaration of Conformity	SC039 *
	ATEX Certificate	FM 10ATEX0003X
	IECEX Certificate	IECEX FME 10.0001X
	FM Certificate (Canada)	FM16CA0176X
	FM Certificate (USA)	FM16US0373X
Switch	Simple Apparatus Declaration	EXPO 20MDOC1391X *

* Documents are attached to the manual.

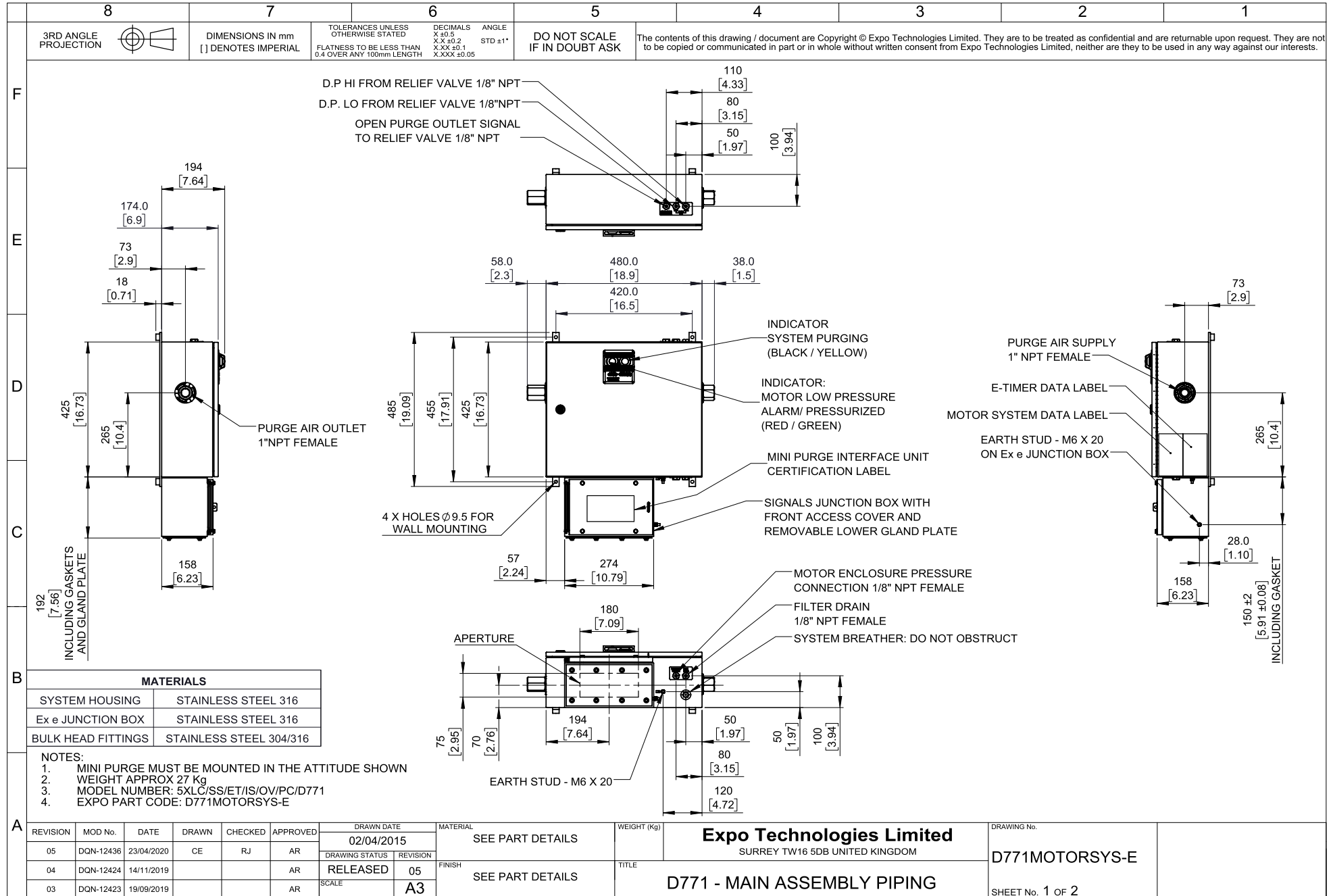

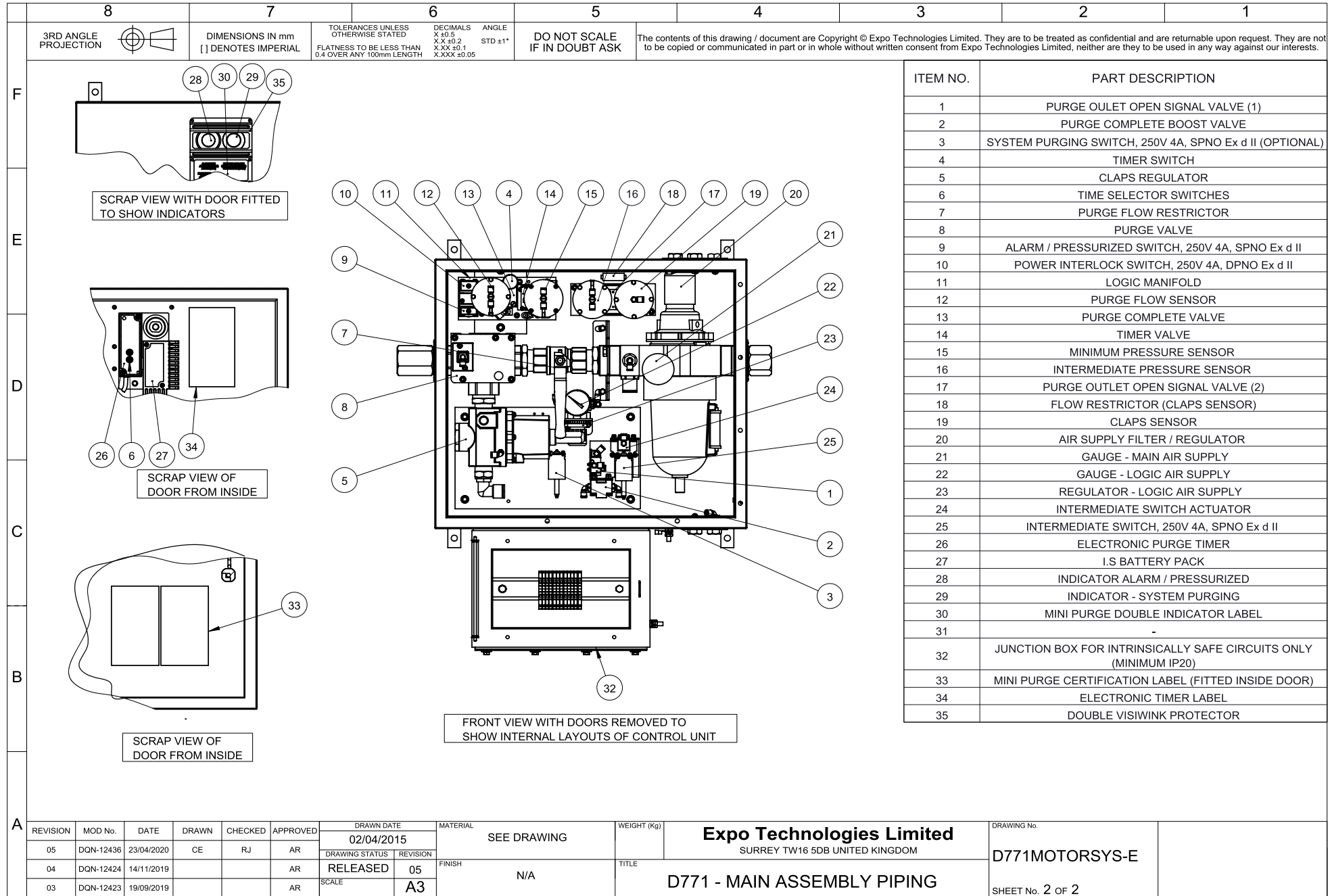

8	7	6	5	4	3	2	1
3RD ANGLE PROJECTION	DIMENSIONS IN mm [] DENOTES IMPERIAL	TOLERANCES UNLESS OTHERWISE STATED FLATNESS TO BE LESS THAN 0.4 OVER ANY 100mm LENGTH	DECIMALS X ±0.5 XX ±0.2 XXX ±0.1 XXX ±0.05	ANGLE STD ±1°	DO NOT SCALE IF IN DOUBT ASK	The contents of this drawing / document are Copyright © Expo Technologies Limited. They are to be treated as confidential and are returnable upon request. They are not to be copied or communicated in part or in whole without written consent from Expo Technologies Limited, neither are they to be used in any way against our interests.	

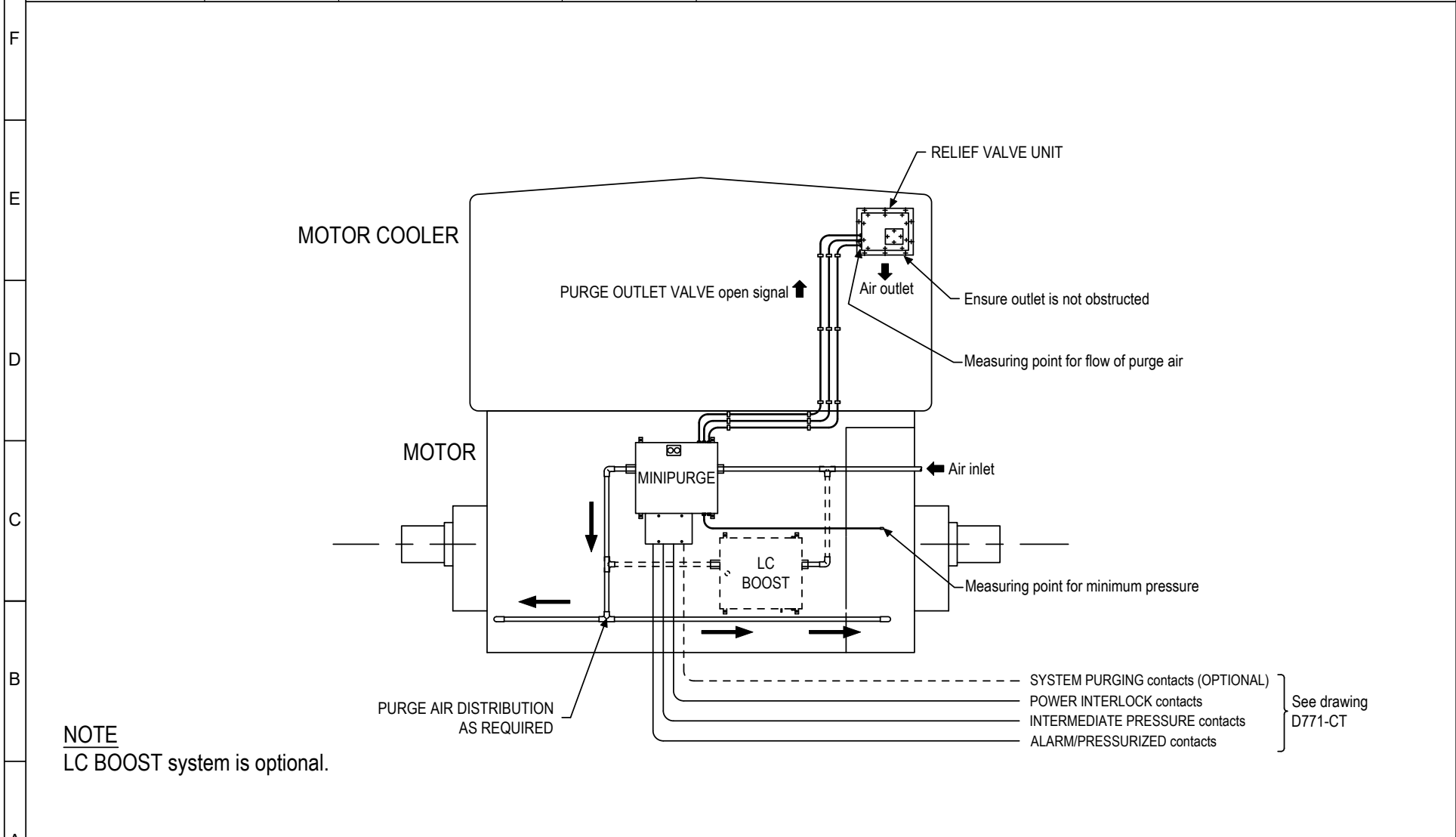

NOTE
 LC BOOST system is optional.

A	REVISION	MOD #	DATE	DRAWN	CHECKED	APPROVED	DRAWN DATE	MATERIAL	WEIGHT (Kg)	Expo Technologies Limited SURREY TW16 5DB UNITED KINGDOM	DRAWING No.	
	02	DQN-12436	27/04/20	CE	AR	MH	25/02/2010				D771-HU	
	01	DRAWN	25/02/10	NRB	JPdB	JPdB	CERT REL	02				
							SCALE N.T.S	A3		D771 TYPICAL HOOK UP		

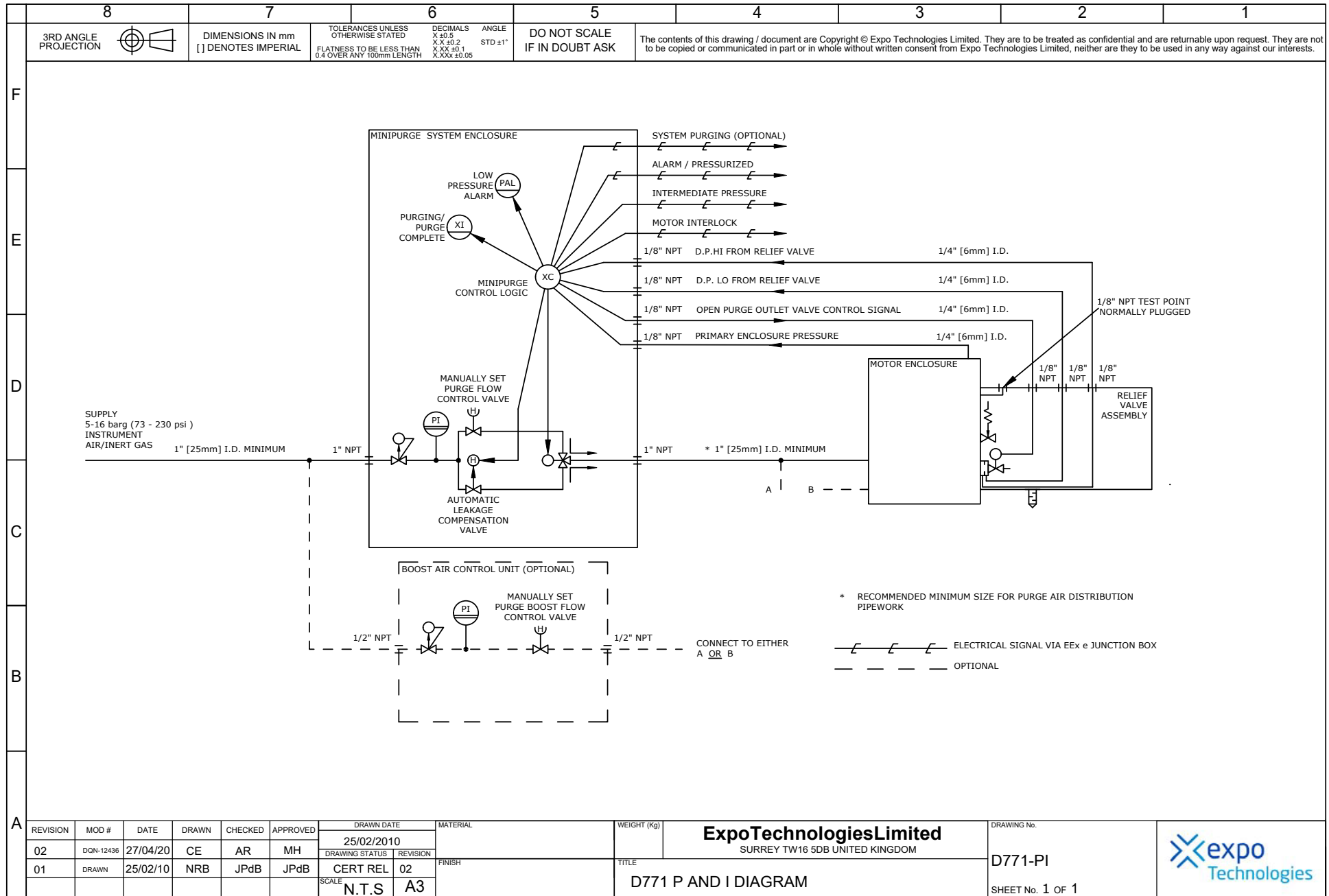

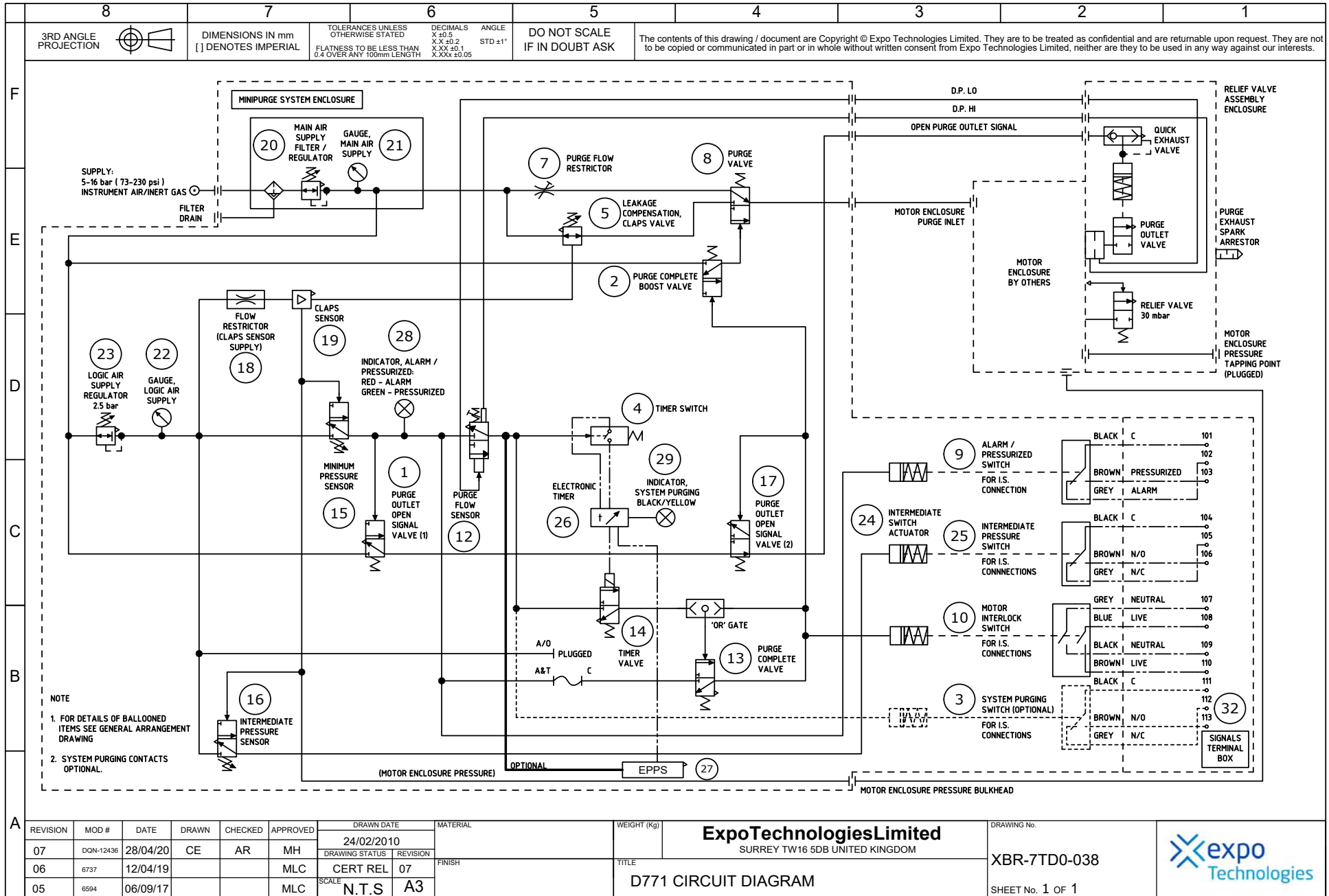

8	7	6	5	4	3	2	1
3RD ANGLE PROJECTION	DIMENSIONS IN mm [] DENOTES IMPERIAL	TOLERANCES UNLESS OTHERWISE STATED FLATNESS TO BE LESS THAN 0.4 OVER ANY 100mm LENGTH	DECIMALS X ±0.5 XX ±0.2 XXX ±0.1 XXXx ±0.05	ANGLE STD ±1°	DO NOT SCALE IF IN DOUBT ASK	The contents of this drawing / document are Copyright © Expo Technologies Limited. They are to be treated as confidential and are returnable upon request. They are not to be copied or communicated in part or in whole without written consent from Expo Technologies Limited, neither are they to be used in any way against our interests.	

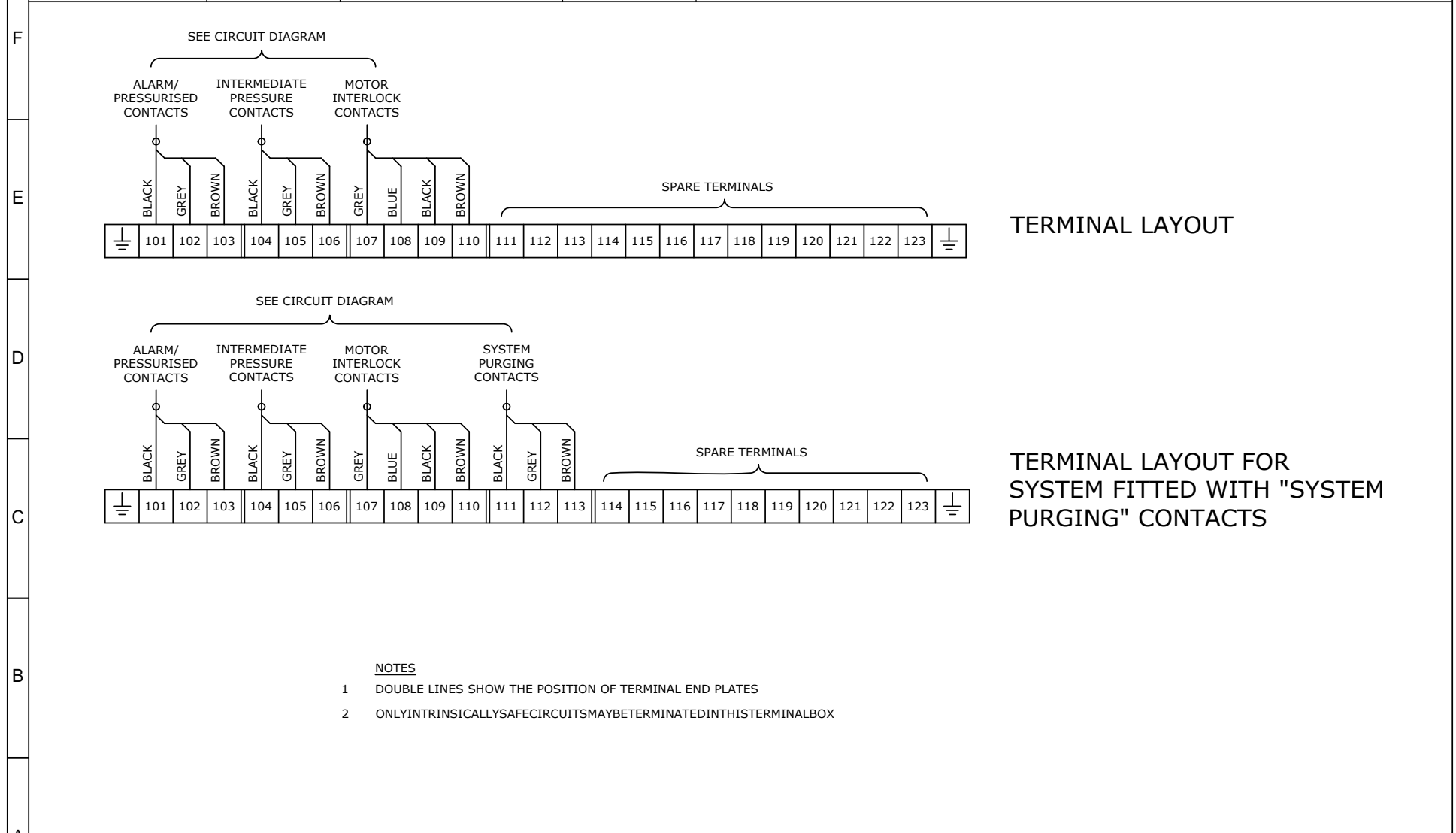

- NOTES**
- 1 DOUBLE LINES SHOW THE POSITION OF TERMINAL END PLATES
 - 2 ONLY INTRINSICALLY SAFE CIRCUITS MAY BE TERMINATED IN THIS TERMINAL BOX

A	REVISION	MOD #	DATE	DRAWN	CHECKED	APPROVED	DRAWN DATE	MATERIAL	WEIGHT (Kg)	Expo Technologies Limited SURREY TW16 5DB UNITED KINGDOM	DRAWING No.
	04	DQN-12436	27/04/20	CE	AR	MH	30/05/2008				AGE-WC00-164
	03	4832	09/12/09			JPdB	CERT REL	04			
	02	4701	03/06/09			JPdB	N.T.S	A3			SHEET No. 1 OF 1
D771 TERMINAL BOX LAYOUT											

8	7	6	5	4	3	2	1
3RD ANGLE PROJECTION	DIMENSIONS IN mm [] DENOTES IMPERIAL	TOLERANCES UNLESS OTHERWISE STATED FLATNESS TO BE LESS THAN 0.4 OVER ANY 100mm LENGTH	DECIMALS X ±0.5 XX ±0.2 XXX ±0.1 X.XX ±0.05	ANGLE STD ±1°	DO NOT SCALE IF IN DOUBT ASK	The contents of this drawing / document are Copyright © Expo Technologies Limited. They are to be treated as confidential and are returnable upon request. They are not to be copied or communicated in part or in whole without written consent from Expo Technologies Limited, neither are they to be used in any way against our interests.	

F
E
D
C
B
A

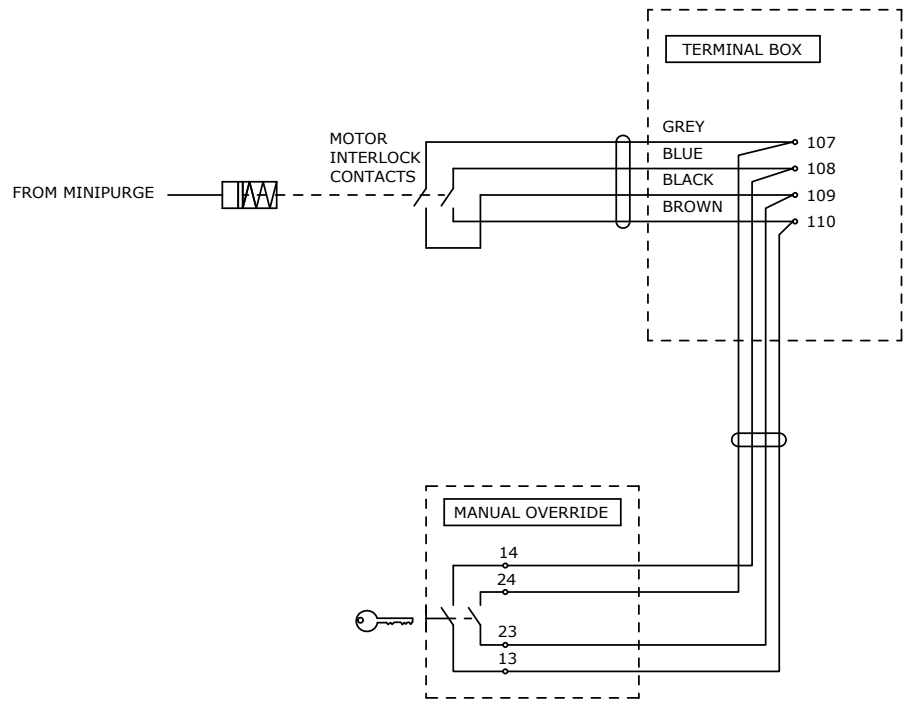

MANUAL OVERRIDE SWITCH SUPPLIED LOOSE.
 GLAND PLATE IN PURGE SYSTEM IS UNDRILLED.
 CABLE GLANDS ARE NOT SUPPLIED.

FOR USE ONLY AS PART OF AN INTRINSICALLY SAFE CIRCUIT

A	REVISION	MOD #	DATE	DRAWN	CHECKED	APPROVED	DRAWN DATE	MATERIAL	WEIGHT (Kg)	ExpoTechnologiesLimited SURREY TW16 5DB UNITED KINGDOM	DRAWING No.
	03	DQN-12436	27/04/20	CE	AR	MH	10/12/2009				AGE-WC00-186
	02	5400	18/11/11			JPdB	CERT REL	03			
	01	DRAWN	10/12/09	NRB	BRD	JPdB	SCALE N.T.S	A3			SHEET No. 1 OF 1



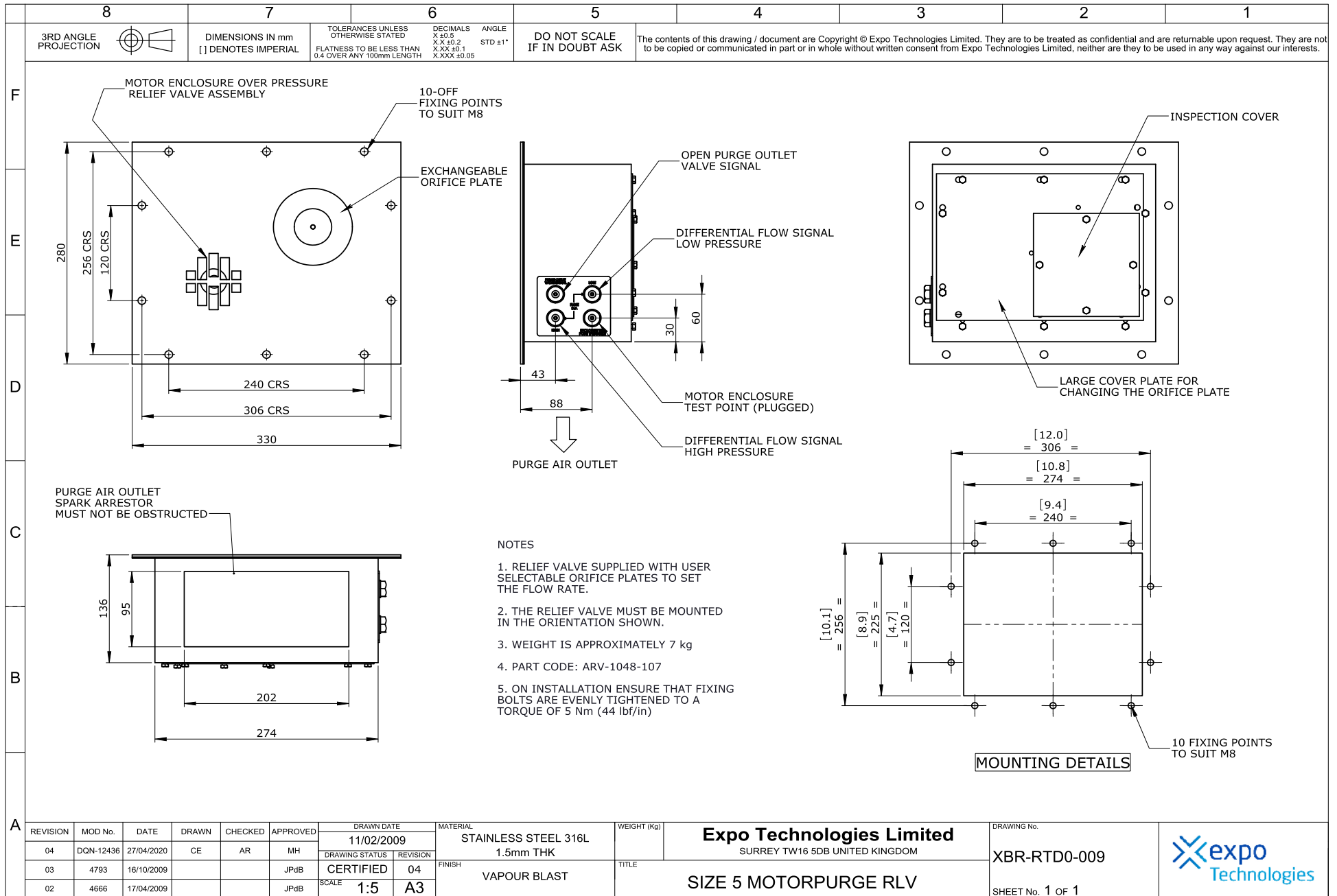

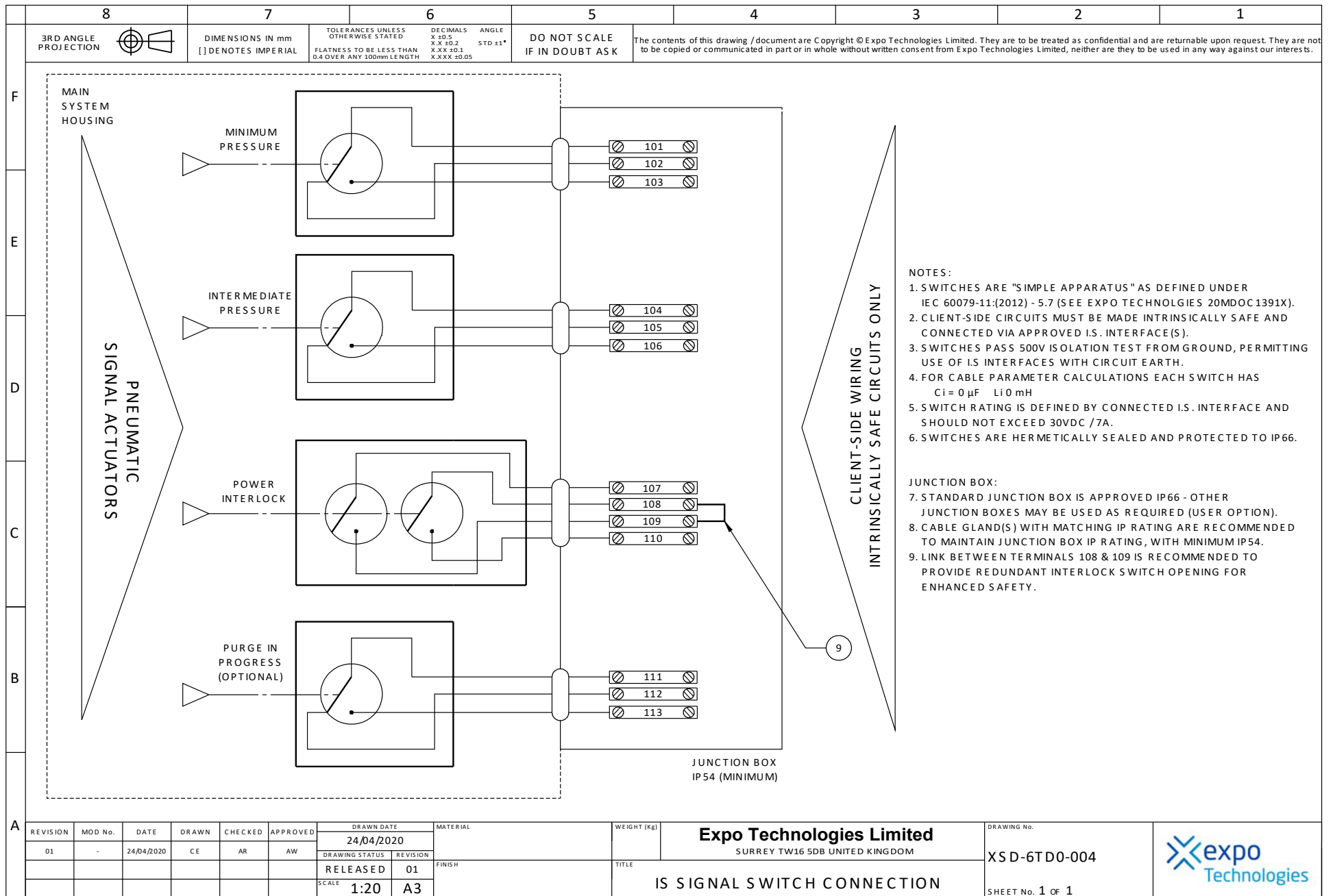

A	REVISION	MOD No.	DATE	DRAWN	CHECKED	APPROVED	DRAWN DATE	MATERIAL	WEIGHT (Kg)	Expo Technologies Limited	DRAWING No.
	01	-	24/04/2020	CE	AR	AW	24/04/2020			SURREY TW16 5DB UNITED KINGDOM	XSD-6TD0-004
							DRAWING STATUS	REVISION			
							RELEASED	01			
							SCALE	1:20			
								A3			
										IS SIGNAL SWITCH CONNECTION	SHEET No. 1 of 1





EU Authorised Representative:
ExpoPharma Engineering Services Ltd
46 Eastcote Drive, Little Island,
Co. Cork, T45 W/R68, Ireland.
E EUAR@expopharma.ie

Manufacturer:
Expo Technologies Ltd
Unit 2, The Summit, Hanworth Road,
Sunbury-on-Thames, TW16 5DB, U.K.
E sales@expoworldwide.com

EU Declaration of Conformity

This is to declare that the products listed below are manufactured in conformity with the following EU Directives under the sole authority of Expo Technologies Ltd:

Electromagnetic Compatibility Directive 2014/30/EU

MiniPurge Systems with a /PO suffix in the type number are non-electrical and are outside the scope of the EMC Directive. MiniPurge Systems with suffices /PA or /IS incorporate one or more volt-free ("dry") contacts which work in circuits specified by others. In normal operation these circuits are "benign" and no CE mark is appropriate. MiniPurge Systems with Electronic Timer (Option /ET and /ES) are designed to conform to the EMC Directive, in compliance with EN 61000-6-4:2007 and EN 61000-6-2:2005 (Intertek Report EM10048000) and 61000-6-4:2007 + A1:2011 and EN 61000-6-2:2005 (Intertek Report 102569070LHD-001) respectively.

Low Voltage Directive 2014/35/EU

MiniPurge Systems are intended for use in potentially explosive atmospheres (Hazardous Areas) and are therefore excluded from the Low Voltage Directive.

Pressure Equipment Directive 2014/68/EU

MiniPurge Systems are classified as not higher than category I under Article 13 of this Directive and intended for use in potentially explosive atmospheres (Hazardous Areas) and are therefore excluded from the Pressure Equipment Directive. MiniPurge Systems are covered under ATEX Directive 2014/34/EU.

ATEX Directive 2014/34/EU

MiniPurge Systems are designed to conform to the above Directive in fulfilment of the Essential Health & Safety requirements of Annexe II and in compliance with:

EN IEC 60079-0:2018 EN 60079-2:2014 EN 60079-11:2012

MiniPurge Systems are certified under EU Type-Examination Certificate Sira 01ATEX1295X by CSA Group (Netherlands) B.V., in compliance with:

EN 60079-0:2012 + A11:2013 EN 60079-2:2014 EN 60079-11:2012

MiniPurge Systems are manufactured under Production Quality Assurance Notification SIRA S9ATEXM043, issued by CSA Group (Netherlands) B.V. (EU Notified Body No. 2813).

Technical documentation and assessments are in the Expo Technologies confidential technical file SC004.

For and on behalf of Expo Technologies Ltd

John Paul De Beer
Managing Director

Date 23rd November 2021

SC004 EU DoC MiniPurge Systems Iss. 16



Manufacturer:
Expo Technologies Ltd
Unit 2, The Summit, Hanworth Road,
Sunbury-on-Thames, TW16 5DB, U.K.
E sales@expoworldwide.com

UK Declaration of Conformity



This is to declare that the products listed below are manufactured in conformity with the following UK Product Regulations under the sole authority of Expo Technologies Ltd

MiniPurge® Purge & Pressurization Systems

A range of systems intended to provide explosion protection of electrical enclosures through purge & pressurization under international and national standards.

Electromagnetic Compatibility Regulations 2016 (SI 2016/1091)

MiniPurge Systems with a /PO suffix in the type number are non-electrical and are outside the scope of the EMC Regulations.

MiniPurge Systems with suffices /PA or /IS incorporate one or more volt-free ("dry") contacts which work in circuits specified by others. In normal operation these circuits are "benign" and no UKCA mark is appropriate.

MiniPurge Systems with Electronic Timer (Option /ET and /ES) are designed to conform to the EMC Regulations, in compliance with EN 61000-6-4:2007 and EN 61000-6-2:2005 (Intertek Report EM10048000) and 61000-6-4:2007 + A1:2011 and EN 61000-6-2:2005 (Intertek Report 102569070LHD-001) respectively.

Electrical Equipment (Safety) Regulations 2016 (SI 2016/1101)

MiniPurge Systems are intended to be used in potentially explosive areas (hazardous areas) and are therefore excluded from the Regulation.

Pressure Equipment (Safety) Regulations 2016 (SI 2016/1105)

MiniPurge Systems are classified as not higher than Category I under article 13 of this Regulation and also intended for use in potentially explosive atmospheres and are therefore excluded from this Regulation.

Equipment and Protective Systems intended for use in Potentially Explosive Atmospheres Regulations, UKSI 2016:1107 (as amended) - Schedule 3A Part 1

MiniPurge Systems are designed to conform to the above Regulations in fulfilment of the Essential Health & Safety requirements of Annexe II and in compliance with:

EN IEC 60079-0:2018 EN 60079-2:2014 EN 60079-11:2012

MiniPurge Systems are certified under UK Type-Examination Certificate CSAE 21 UKEX 1067X by CSA Group Testing UK Ltd. (UK Conformity Assessment Body No. 0518) in compliance with:

EN 60079-0:2012 + A11:2013 EN 60079-2:2014 EN 60079-11:2012

MiniPurge Systems are manufactured under Production Quality Assurance Notification CSAE 21 UKQAN 0005, issued by CSA Group Testing UK Ltd. (UK Conformity Assessment Body No. 0518).

Technical documentation and assessments are in the Expo Technologies confidential technical file SC004.

For and on behalf of Expo Technologies Ltd

John Paul De Beer
Managing Director

Date 15th December 2021

SC004-UK.v1 UKCA DoC MiniPurge Iss. 1



EU Authorized Representative:
ExpoPharma Engineering Services Ltd
46 Eastcote Drive, Little Island,
Co. Cork, T45 WR68 Ireland.
E EUAR@expopharma.ie

Manufacturer:
Expo Technologies Ltd
Unit 2, The Summit, Hanworth Road,
Sunbury-on-Thames, TW16 5DB, U.K.
E sales@expoworldwide.com

EU Declaration of Conformity



This is to declare that the products listed below are manufactured in conformity with the following EU Directives under the sole authority of Expo Technologies Ltd:

Electronic Timer Modules Type ETM-IS**_***

The ETM-IS is a powered electronic timer module designed to be powered by a battery or power supply. The battery pack contains a non-rechargeable battery. The timer settings are controlled by two BCD switches. Connections from the timer to a switch to enable timing and a solenoid valve which is used to terminate the timing cycle are provided. The solenoid valve is supplied with the timer and battery or power supply (certified separately). Four LED's are used to indicate the status of the timer circuit.

Low Voltage Directive 2014/35/EU

Electronic Timer Modules Type ETM-IS**_*** are intended for use in potentially explosive atmospheres (Hazardous Areas) and are therefore excluded from the Low Voltage Directive.

ATEX Directive 2014/34/EU Equipment for explosive atmospheres

Electronic Timer Modules Type ETM-IS**_*** are designed to conform to the ATEX Directive in fulfilment of the essential health and safety requirements set out in Annex II, and in compliance with:

EN 60079-0: 2018

EN 60079-11: 2012

Electronic Timer Modules Type ETM-IS**_*** are certified by FM Approvals Europe Ltd. One Georges Quay Plaza, Dublin, Ireland. D02 E440, under EU Type-Examination Certificate FM10ATEX0003, in compliance with:
EN 60079-0: 2012 + A11:2013 **EN 60079-11: 2012**

Electronic Timer Modules Type ETM-IS**_*** are rated and shall be marked as follows:

Group II Category 1 G



Group II Category 1 D



Electronic Timer Modules Type ETM-IS**_*** are manufactured under Production Quality Assurance Notification SIRA 99 ATEX M043, issued by CSA Group Netherlands B.V. (CSA), Notified Body No 2813.

Signed for and on behalf of Expo Technologies Ltd.,

John Paul De Beer
Managing Director

Date 2nd November 2021
Confidential Assessment file reference SC039

SC039 Electronic Timer EU DoC Issue 4



(1) **MANUFACTURERS DECLARATION OF CONFORMITY**

(2) Expo Technologies Document Number
EXPO 20MDOC1391X

(3) This declaration is issued for the electrical apparatus:

AGE-SW0Z-035 SPCO Switch
AGE-SW0Z-036 DPNO Switch

(4) Manufacturer

Expo Technologies Ltd
Unit 2 The Summit, Hanworth Road
Sunbury-on-Thames, Surrey
TW16 5DB, UK

(5) This electrical apparatus and any acceptable variation thereto is specified in the Annex to this declaration and the documents therein referred to.

(6) This declaration and schedule confirms compliance of each unit with the following standards:

IEC 60079-0 : 2017 General requirements
IEC 60079-11: 2011 Equipment protection by intrinsic safety "i"

in respect of being 'simple apparatus' for the purposes of interfacing Expo Technologies pneumatic systems with external electrical circuits protected by intrinsically safe interfaces and assessed / installed as intrinsically safe circuits (by others).

(7) This apparatus fulfils all the requirements for 'simple apparatus' under IEC 60079-11:2011 Section 5.7

(8) The design is documented in Expo Technologies Confidential Assessment File number 55839

(9) The apparatus marking (simple apparatus is exempt from IEC 60079-11 marking requirements):

$$C_i = 0 \mu F \quad L_i = 0 mH$$

Tested for 500V ac rms isolation

For and on behalf of Expo Technologies Ltd

M. C. O'Neill
Consultant Engineer - Certification
20th April 2020

Annex to Declaration of Conformity EXPO 20MDOC1391X

10 Description

Expo Technologies purge & pressurization systems incorporate switches which interface between the Expo pneumatic logic and the users' electrical system. These switches are Type 07-2511, manufactured by Bartec GmbH, Germany. The switches themselves are approved and marked Ex d under Certificates EPS 14ATEX1766X and EPS 14.0092X (IECEx), complete with declaration as sealed units to IP66.

In the Expo application, the switches are expected to be connected to intrinsically safe circuits. To that end, the switches have been assessed by Expo Technologies as meeting the requirements of 'simple apparatus' as defined under IEC 60079-11:2011 Section 5.7.

11 Special conditions of safe use

The component may only be connected to a circuit made intrinsically safe via an approved intrinsically safe interface (by others). Assessment of any such intrinsically safe circuit is outside the scope of this declaration save that the switch contact loading should not exceed 30V / 7A.

The component may be considered to add 0 μF (capacitance) and 0 mH (inductance) to such a circuit.

12 Verifications and tests

The component (or representative sample per batch) has been shown to comply with the circuit insulation requirements of Section 6.3.13 IEC 60079-11:2011. Expo Test Procedure TP-518-088-WD applies.

13 Installation Instructions

The installation shall comply with the requirements of IEC 60079-14:2013, in particular Section 16: Additional requirements for types of protection "i" – intrinsic safety.

Switches are generally afforded a T6 rating when installed as part of an intrinsically safe circuit.

14 Drawings

Description	Doc Reference	Rev.	Date
I.S. Signal Switch Connection	XSD-6TDO-004	01	24/04/2020
Confidential Assessment File	Ex.TR 55839		

<END>